



## 04-08 FORD F150 4" KIT

### THANK YOU FOR CHOOSING ROUGH COUNTRY FOR YOUR SUSPENSION NEEDS.

Rough Country recommends a certified technician install this system. In addition to these instructions, professional knowledge of disassemble/reassembly procedures as well as post installation checks must be known. Attempts to install this system without this knowledge and expertise may jeopardize the integrity and/or operating safety of the vehicle.

Please read instructions before beginning installation. Check the kit hardware against the parts list on the next 2 pages. Be sure you have all needed parts and know where they go. Also please review tools needed list and make sure you have needed tools.

### PRODUCT USE INFORMATION

As a general rule, the taller a vehicle is, the easier it will roll. We strongly recommend, because of rollover possibility that seat belts and shoulder harnesses should be worn at all times. Avoid situations where a side rollover may occur.

Generally, braking performance and capability are decreased when larger/heavier tires and wheels are used. Take this into consideration while driving. Do not add, alter, or fabricate any factory or after-market parts to increase vehicle height over the intended height of the Rough Country product purchased. Mixing component brands is not recommended.

Rough Country makes no claims regarding lifting devices and excludes any and all implied claims. We will not be responsible for any product that is altered. If questions exist we will be happy to answer them concerning the design, function, and correct use of our products.

This suspension system was developed using a 35X12.50/17, tire on aftermarket 17" wheels with 4 1/2-5" backspace. The lift was designed to lift the front 4" and the rear 2" to level the vehicle. Due to manufacturing, dimension variances, and inflation all tire and wheel combinations should be tested prior to installation on all oversized / wider then stock tires. We recommend a wheel not exceeding 8" in width be used with a minimum backspacing of 4.5" to a maximum of 5".

**Rough Country recommends not operating the vehicle in 4 wheel drive above 40 mph. Doing so may result in a low frequency front driveshaft vibration. See Driveshaft Re-clocking Instructions.**

### NOTICE TO DEALER AND VEHICLE OWNER

Any vehicle equipped with any Rough Country product should have a "Warning to Driver" decal installed on the inside of the windshield or on the vehicle's dash. The decal should act as a constant reminder for whoever is operating the vehicle of its unique handling characteristics.

#### Tools Needed:

5mm wrench /socket	Floor Jack
8mm wrench /socket	Jack stands
10mm wrench /socket	Hammer
11mm wrench /socket	7/16" wrench /socket
12mm 12 point wrench	9/16 wrench /socket
14mm wrench /socket	5/8" wrench /socket
15mm wrench /socket	3/4" wrench /socket
16mm wrench /socket	1 1/16 socket
18mm wrench /socket	Drill
19mm wrench /socket	17/32" Drill Bit
21mm wrench /socket	
22mm wrench /socket	
24mm wrench /socket	
30mm wrench /socket	

#### Torque Specs:

Size	Grade 5	Grade 8
5/16"	15 ft/lbs	20 ft/lbs
3/8"	30 ft/lbs	35 ft/lbs
7/16"	45 ft/lbs	60 ft/lbs
1/2"	65 ft/lbs	90 ft/lbs
9/16"	95 ft/lbs	130 ft/lbs
5/8"	135 ft/lbs	175 ft/lbs
3/4"	185 ft/lbs	280 ft/lbs
	Class 8.8	Class 10.9
6MM	5 ft/lbs	9 ft/lbs
8MM	18ft/lbs	23 ft/lbs
10MM	32ft/lbs	45ft/lbs
12MM	55ft/lbs	75ft/lbs
14MM	85ft/lbs	120ft/lbs
16MM	130ft/lbs	165ft/lbs
18MM	170ft/lbs	240ft/lbs

## KIT CONTENTS

### 1577 BOX 1

PART #	DESCRIPTION	QTY
94003702	REAR CROSSMEMBER	1
94003703	DIFF DROP	2
94003710	BRAKE LINE BRACKET	1
94003709	PASS DIFF BRACKET	1
94003042	STRUT SPACER	2
94003713	RACK & PINION BRACKET	2

### 1576 BOX 2

PART #	DESCRIPTION	QTY
94003701	FRONT CROSSMEMBER	1
337403	PASS SIDE BRAKE LINE	1
337303	DR SIDE BRAKE LINE	1
94003705	SWAY BAR DROP BRKT	2
94003706	SKID PLATE	1
94003715	REAR BRAKE LINE BRKT	1

### 1576 BOX 3

PART #	DESCRIPTION	QTY
94003712	DRIVER KNUCKLE	1

### 1576 BOX 4

PART #	DESCRIPTION	QTY
94003711	PASS KNUCKLE	1

### 1577 BOX 5

PART #	DESCRIPTION	QTY
90905500	9/16" x 3 X 11" U-BOLT	4
90909200	2" REAR BLOCK	2
9/16BAG	U-BOLT NUT BAG	1
94003714	RACK & PINION SPACER	2
84164W	STICKER	1
658048	REAR SHOCK	2

### 1576 BAGS (IN BOX 5)

*For Pass Side Diff Bracket:*

12MM X 100MM BOLT	1
12MM FLANGE LOCK NUT	1

*For Driver Side Diff Bracket:*

12MM x 90MM BOLT	1
12MM FLANGE LOCK NUT	1
12MM FLAT WASHER	2

*For the Front and Rear Cross member:*

18MM X 150MM CAM BOLTS	4
18MM WASHERS	4
18MM NUTS	4

*For the Skid Plate:*

3/8" X 1" SELF TAPPING BOLT	4
-----------------------------	---

*For Sway Bar Brackets:*

3/8" NUT	4
3/8" X 1" BOLT	4
3/8" WASHERS	8

*For Strut Spacers:*

3/8" STUDS	6
3/8" NUT	6
3/8" LOCK WASHER	6
3/8" FLAT WASHER	6

*For Differential:*

DIFF HOSE COUPLER	1
DIFF HOSE	1

*For the Rack and Pinion Brackets:*

16MM X 130MM BOLT	2
16MM FLAT WASHER	4
16MM NUT	2
SPACERS	2

*For the Front Brake Lines:*

BRAKE CRUSH WASHER	4
BRAKE LINE CLIP	2

*For E-Brake Bracket:*

5/16" X 1" BOLT	1
5/16" WASHER	2
5/16" NUT	1

*For the Rear Brake Line Bracket:*

5/16" X 3/4" BOLT	1
5/16" NUT	1
5/16" WASHER	2

*For the Rear U-Bolts:*

9/16" Lock Nuts	8
9/16" Flat Washers	8

### 1576 BAG 2 (IN BOX 5) SHOCK BAG

PART #	DESCRIPTION	QTY
81019	REAR SHOCK BUSHING	4
404739	SHOCK SLEEVE	4

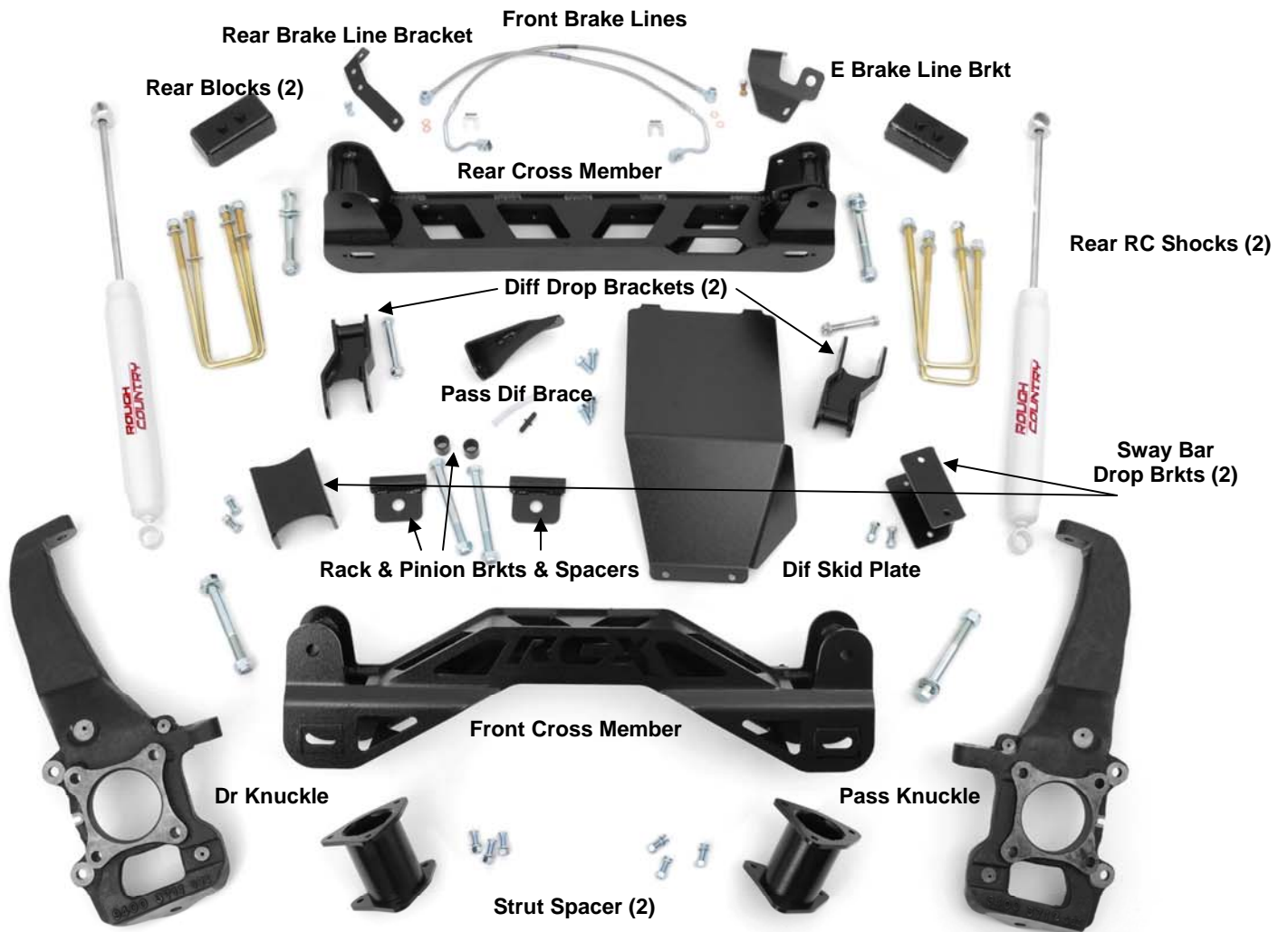

Please make sure you have all the needed parts and fully understand where they go before starting installation. If there are any questions about these instructions or this product please call your sales tech at 800-222-7023.



## INSTALLATION INSTRUCTIONS

1. Chock the rear wheels and jack up the front of the vehicle.
2. Place jack stands under the frame rails and lower onto jack stands.
3. Remove the wheels/tires.
4. Remove tie-rod end using a 21mm wrench. Using a hammer hit the side of the knuckle to pop tie-rod out. **Photo 1.**
5. Using a 18mm socket remove brake caliper as shown in **Photo 2.** Hang caliper out of way. Do not let caliper hang by brake hose as this will damage hose. Remove rotor.

**PHOTO 1**

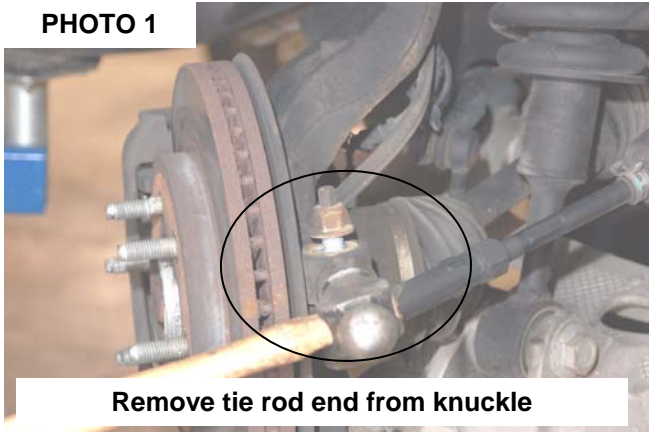

**Remove tie rod end from knuckle**

**PHOTO 2**

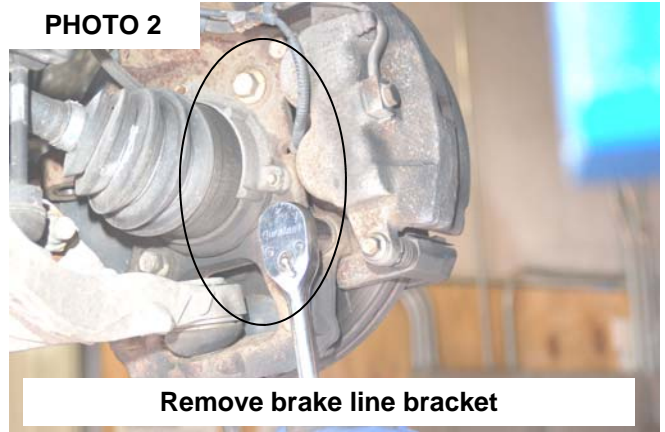

**Remove brake line bracket**

6. Using a 5mm Allen-wrench remove ABS wire from wheel bearing and remove vacuum hoses from knuckle. Retain factory hardware. **See Photo 3.**
7. Remove the dust cap from the knuckle and remove the 13mm axle nut.
8. Remove the upper ball joint nut on the knuckle using a 21mm wrench. Use a hammer as shown in **Photo 4** to separate the ball joint from the knuckle.

**PHOTO 3**

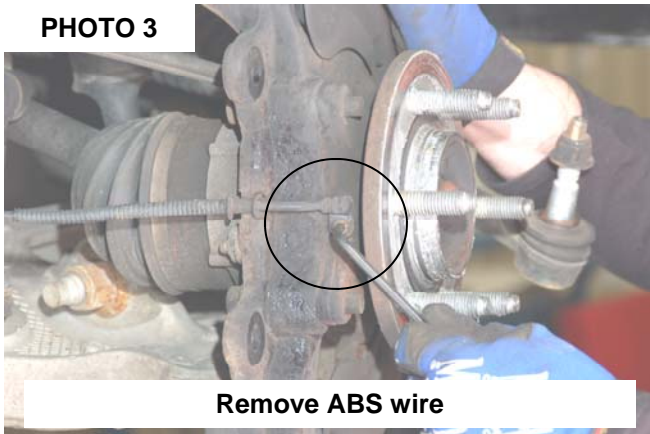

**Remove ABS wire**

**PHOTO 4**



**Remove the upper ball joint from the knuckle**

9. Remove the lower ball joint nut from the knuckle using a 24mm wrench. **See Photo 5.** Use a hammer as shown in **Photo 6.**

**PHOTO 5**

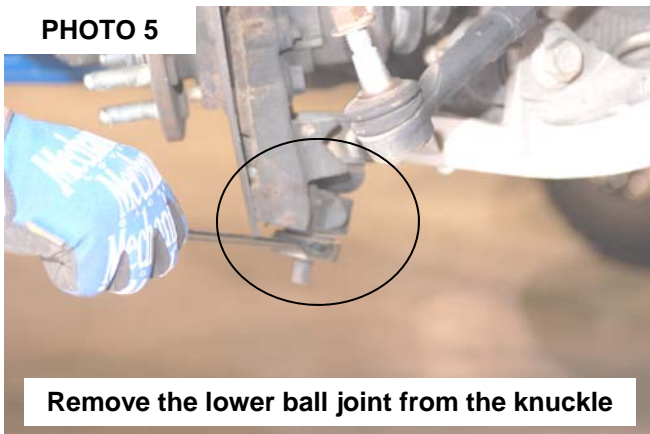

**Remove the lower ball joint from the knuckle**

**PHOTO 6**



**Strike as shown to loosen ball joint**

10. Remove the knuckle from the vehicle. Be sure not to overextend or pull out the CV axle shaft.
11. Repeat steps 4-10 for opposite side of the vehicle.
12. Remove the upper strut mounting nuts as shown in **Photo 7** using a 15mm wrench and retain the nuts for reuse.
13. Remove the lower strut mount bolt from the lower control arm using a 30mm socket and 1 1/16" wrench as shown in **Photo 8** and remove the strut from the vehicle.

**PHOTO 7**

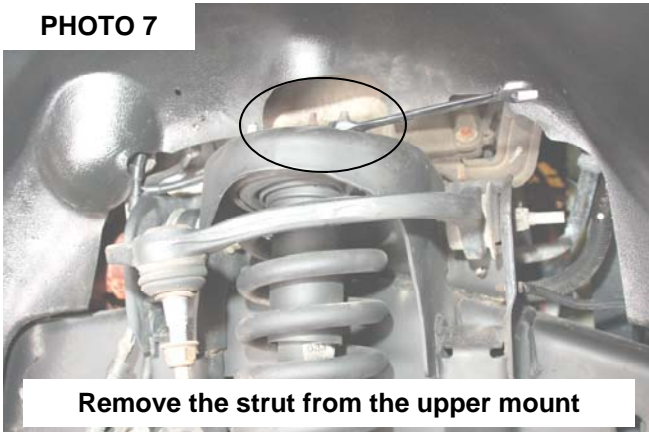

**Remove the strut from the upper mount**

**PHOTO 8**

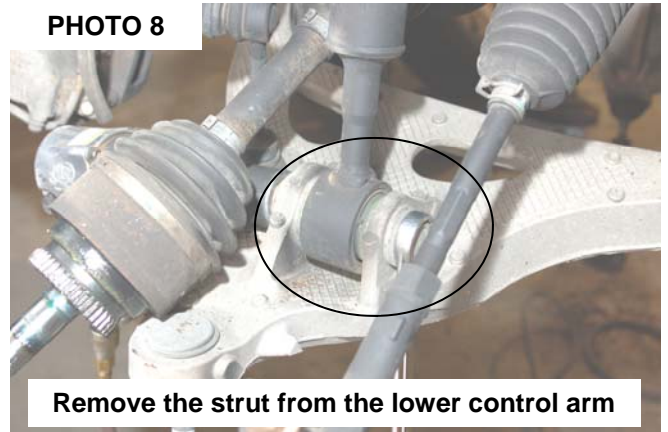

**Remove the strut from the lower control arm**

14. Remove the axle shaft bolts using a 12mm 12point socket as shown in **Photo 9** and remove the axle shaft. Retain the hardware for reuse.
15. Remove the nut from the sway bar link using a 21mm wrench and retain the factory nut. It may be necessary to use a hammer as shown in **Photo 10** to separate the sway bar link from the sway bar.
16. Remove the bolts on the lower control arm using a 21mm and a 1 1/16" wrench and remove the lower control arm.
17. Repeat steps 12-16 for the opposite side.

**PHOTO 9**

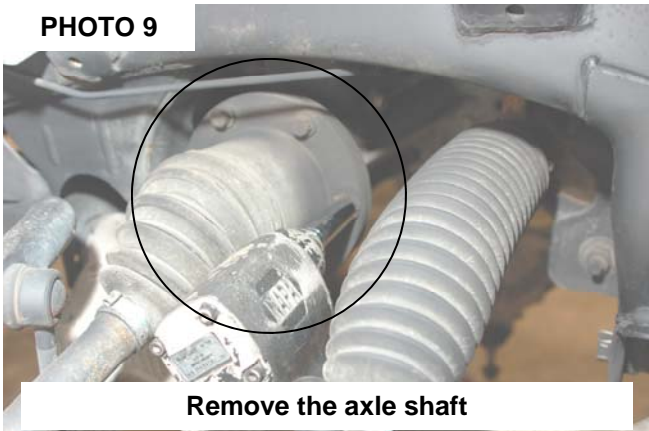

**Remove the axle shaft**

**PHOTO 10**

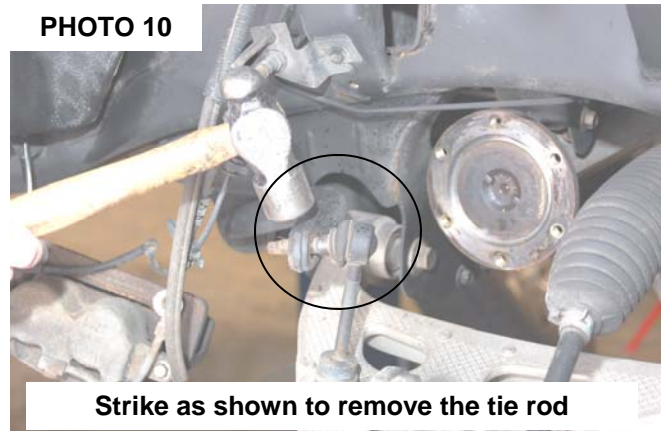

**Strike as shown to remove the tie rod**

18. Remove the center cross-member bolts as shown in **Photo 11** using a 18mm and a 13mm wrench. Remove the cross-member as shown in **Photo 12**.

**PHOTO 11**

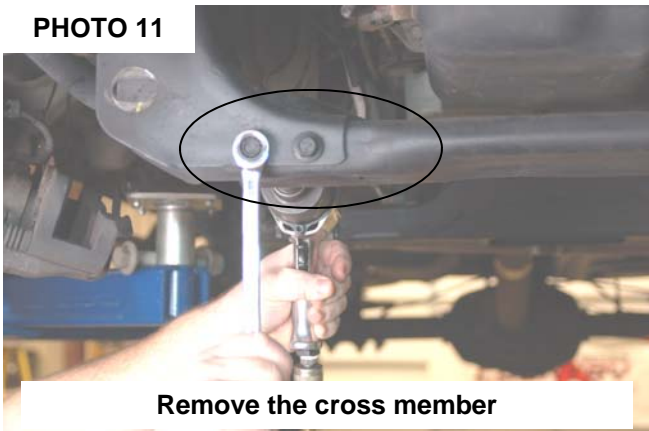

**Remove the cross member**

**PHOTO 12**



**Remove from the vehicle**



19. Remove the sway bar as shown in **Photo 13** using a 15mm socket. Set sway bar aside and retain hardware for re-use.
20. Remove the drive shaft bolts using a 12mm 12point socket. Secure driveshaft out of harms way.
21. On the driver side. Remove the upper differential bolt as shown in **Photo 14** using a 15mm socket. Retain for reuse. It may be necessary to slightly turn the steering wheel to allow the bolt to clear the steering assembly.

**PHOTO 13**

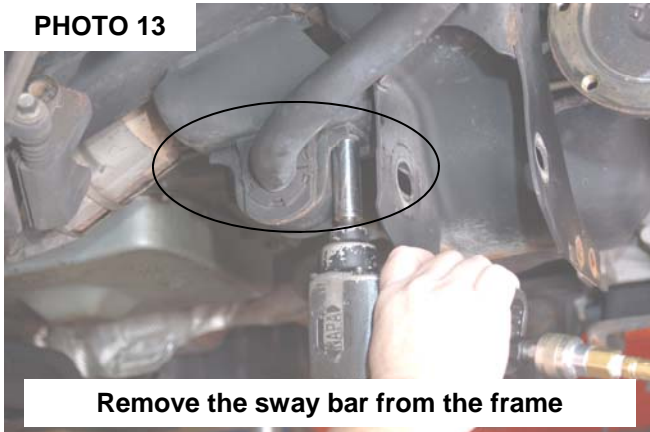

**Remove the sway bar from the frame**

**PHOTO 14**



**Remove the upper Diff Bolt**

22. Loosen the rear driver side bolt and the passenger side bolt on the differential using a 15mm wrench. **Photo 15 and 16.**

**PHOTO 15**



**Remove the driver rear diff bolt**

**PHOTO 16**

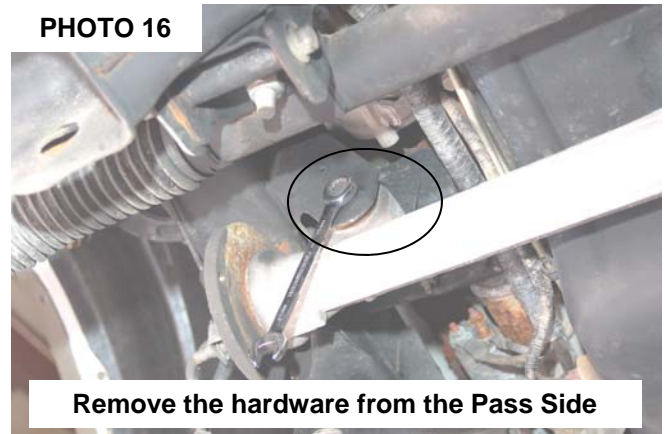

**Remove the hardware from the Pass Side**

23. Place a floor jack under the front differential and remove both bolts and set differential aside.
24. On driver side stock frame; measure over **1 1/8"** from hole as shown and **3 1/2"** from the bottom up. **See Photo 17.** Mark the area and cut using a reciprocating saw. Paint cut area to prevent rusting. Using supplied drilling template (next to last page), mark and drill using a 17/32" bit. **See Photo 18.**

**PHOTO 17**

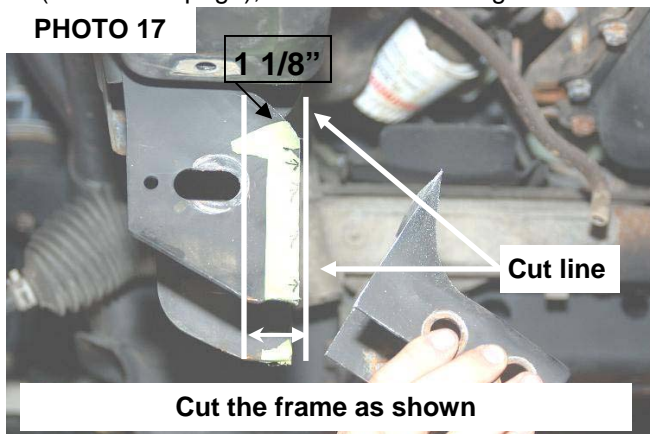

**Cut the frame as shown**

**PHOTO 18**

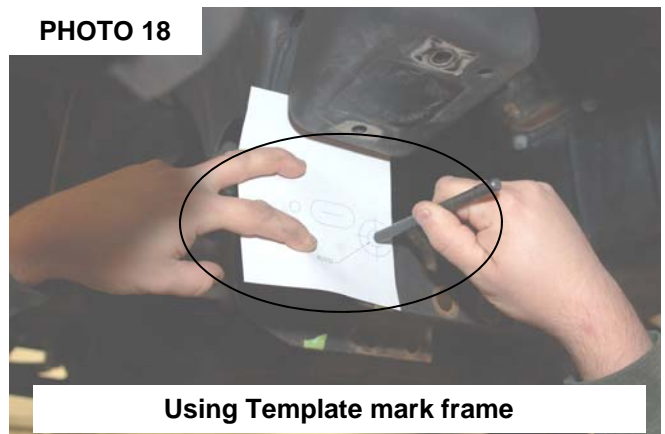

**Using Template mark frame**

25. Remove the oil catch pan using 10mm wrench. **See Photo 19.**
26. Remove the nuts on the rack and pinion mounting bolts using a 24mm socket. Also remove the bolts from the rack and pinion mounting plates using 18mm wrench. Use a jack stand to support the rack and pinion do not let the rack hang or you may damage it or the hoses. **See Photo 20.**

**PHOTO 19**



**Remove the oil catch pan**

**PHOTO 20**



**Remove the Hardware from the rack & pinion**

27. Replace rack and pinion bolts with the new 16mm x 130mm long bolts and install the 1" spacer above the rack and pinion to space the rack down. **See Photo 21.**
28. Install new rack and pinion mounting plates with factory hardware do not tighten at this time. Mount the plate with the hole offset down as shown in **Photo 22.**

**PHOTO 21**

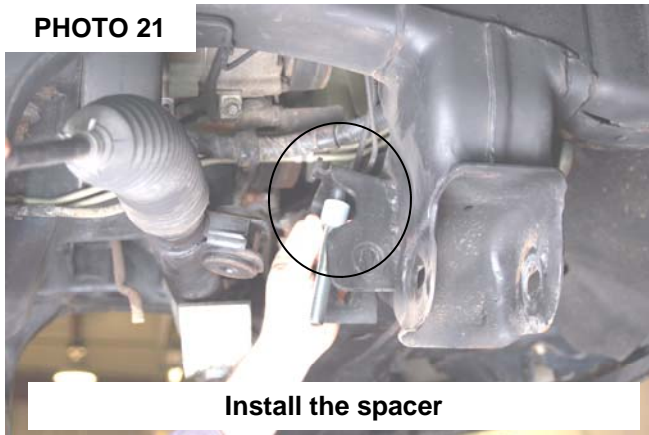

**Install the spacer**

**PHOTO 22**

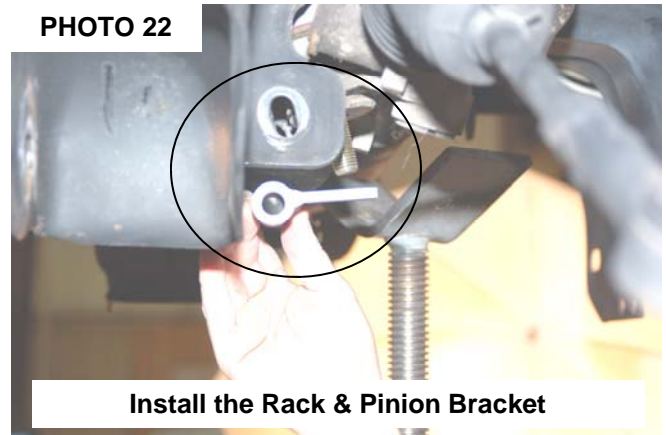

**Install the Rack & Pinion Bracket**

29. Install driver side differential bracket with factory hardware as shown in **Photo 23** with the offset to the front of the vehicle. Do not tighten at this time.
30. Install passenger side differential bracket with factory hardware as shown in **Photo 24** with the offset to the front. Do not tighten at this time.

**PHOTO 23**

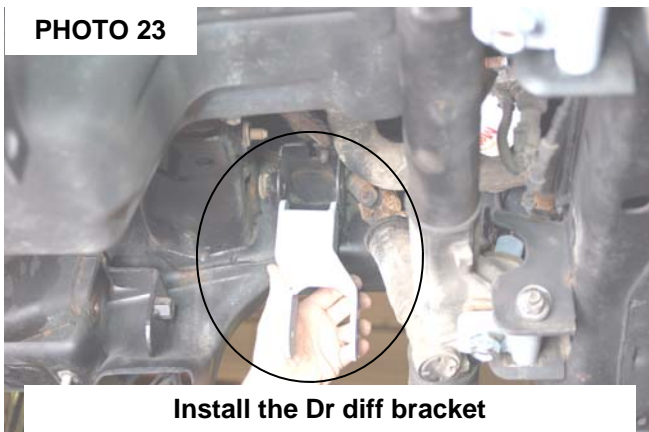

**Install the Dr diff bracket**

**PHOTO 24**



**Install the Pass diff bracket**



31. Raise the differential into position with a floor jack and install using the new 12mm x 100mm bolt on the passenger side. Do not install nut at this time. On the driver side make sure differential clears the rear lower control arm pocket that was cut. Trim if necessary and install the supplied 12mm x 90mm bolts back to front. See **Photo 25**.
32. Install passenger side support bracket to rack and pinion bolt to passenger side differential bolt. See **Photo 26**.

**PHOTO 25**



**Install supplied hardware on Pass side**

**PHOTO 26**



**Install rack & pinion brace bracket**

33. Install rear cross-member using factory bolts and install differential bolt with new 12mm nut shown in **Photo 27**. It may ease installation to tape the nut to the wrench to install on bolt.
34. At this time tighten rack and pinion bolts using a 24mm wrench. Then tighten the rack and pinion mounting plates using 18mm wrench and tighten the upper differential bolts using a 15mm wrench and tighten the lower differential bolts using a 18mm and 19mm wrench. See **Photo 28**.

**PHOTO 27**

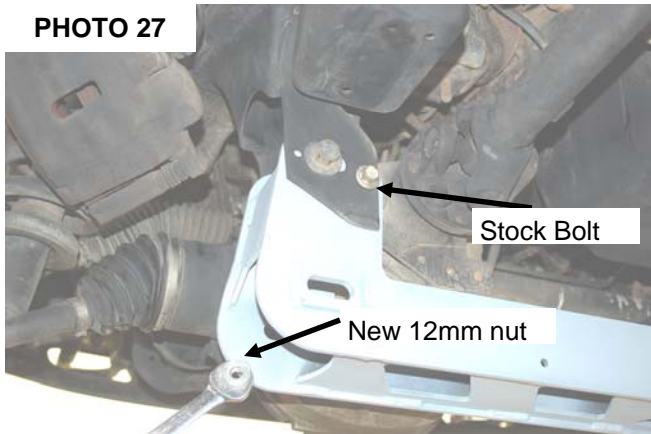

**Stock Bolt**

**New 12mm nut**

**PHOTO 28**



**Tighten the rack and pinion hardware**

35. Install front cross-member using factory hardware. See **Photo 29**. Do not tighten at this time.
36. Install lower control arms using the supplied 18mm x 150mm cam bolts, washers and nuts so the offset washer rests in the tabs on the front and rear cross-members. See **Photo 30**.

**PHOTO 29**

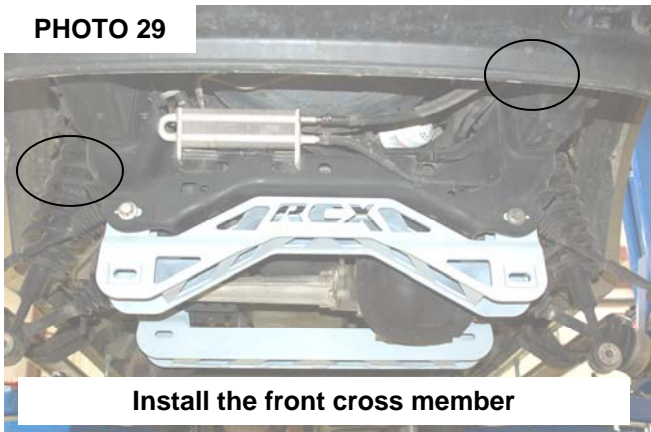

**Install the front cross member**

**PHOTO 30**

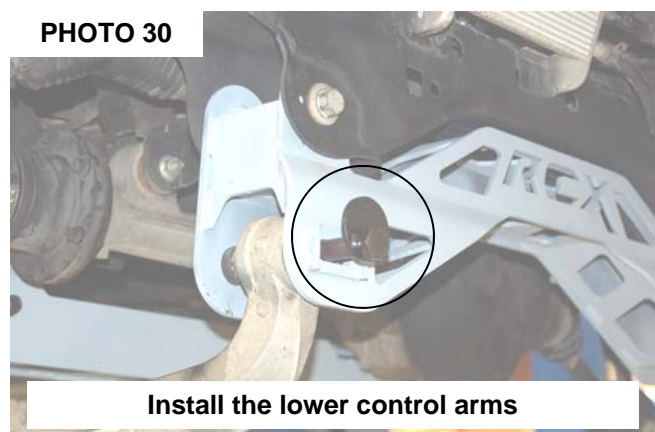

**Install the lower control arms**



37. Install new skid plate using the 3/8 self tapping bolts on front cross member and on the rear cross member using a 9/16" mm wrench as shown in **Photo 31 & 32.**

**PHOTO 31**

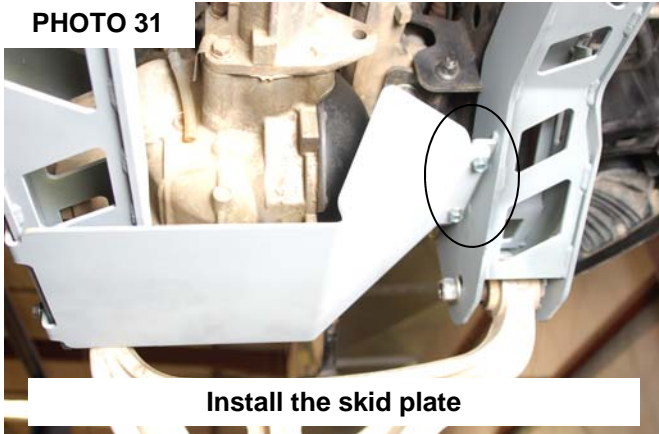

**Install the skid plate**

**PHOTO 32**

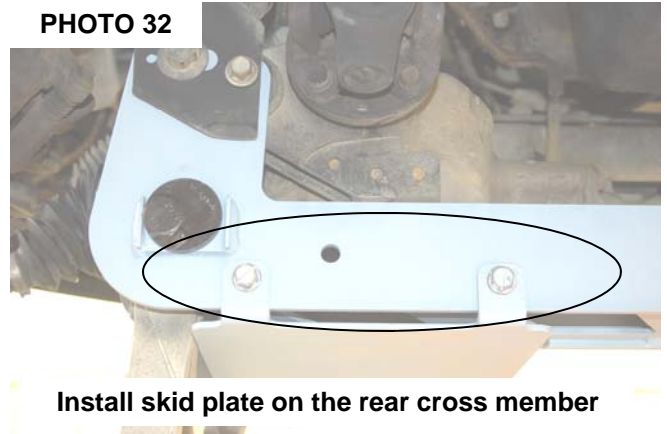

**Install skid plate on the rear cross member**

38. At this time tighten all cross-member bolts using a 21mm and a 1" 1/16 wrench and the rear differential bolt using a 15 mm wrench. **Tighten lower control arm bolts to 200 ft/lbs.**
39. Install the new sway-bar drop brackets on the frame using factory hardware and a 15mm wrench.
40. Reinstall front driveshaft using 12mm 12 point socket.
41. Install the sway bar onto the new bracket using the 3/8 x 1" bolts as shown in **Photo 33.** Tighten using a 9/16" wrench.
42. Reinstall sway-bar link back into sway-bar. Using a 21mm wrench tighten nut.
44. Install the supplied 3/8" self clinching studs in the strut spacer as shown in **Photo 34.** Using a 9/16" socket and torque wrench, torque the nuts to 35-40 ft lbs. This will cinch the studs in the spacer.

**PHOTO 33**



**Install the sway bar drop brackets**

**PHOTO 34**



**Install self tapping studs in the strut spacer**

45. Install the strut spacer on the strut as shown in **Photo 35** with factory hardware. Install the strut in the upper mount on the vehicle as shown in **Photo 36** with the supplied 3/8" flat washers, lock washers and nuts using a 14mm wrench. Install the lower strut mount in the lower control arm with factory hardware and using a 30mm socket and a 1" 1/16 socket.

**PHOTO 35**



**Install the spacer on the strut**

**PHOTO 36**



**Install the assembly in the mount**

46. Remove the inner bearing assembly using 8mm wrench and remove the outer bearing assembly using a 15 mm wrench. **See Photo 37 & 38.**

**PHOTO 37**

Inner bearing assembly bolts

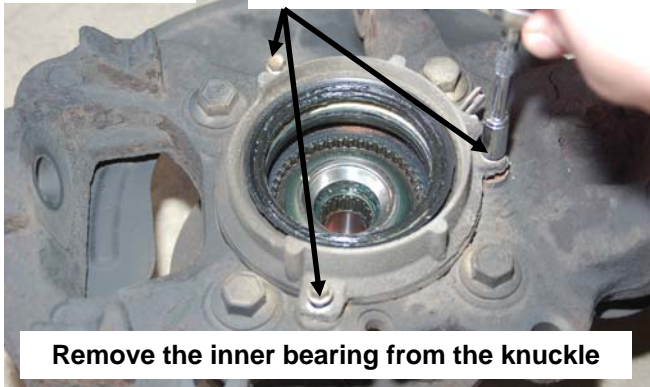

**Remove the inner bearing from the knuckle**

**PHOTO 38**

Outer bearing assembly bolts

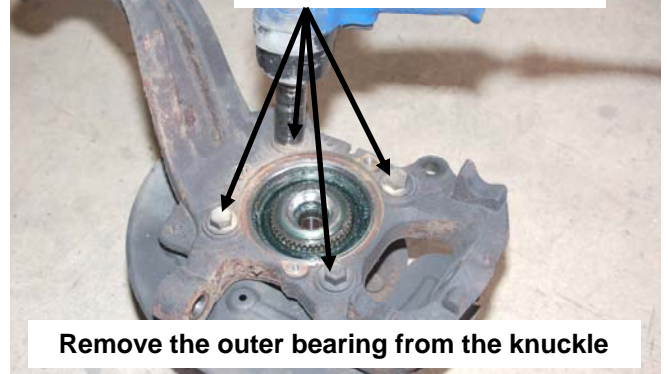

**Remove the outer bearing from the knuckle**

47. Remove the dust shield using a 8mm wrench as shown in **Photo 39** and install to new knuckle. Install bearing assembly into new knuckle. Install the new Rough Country knuckle in the stock location with factory hardware. Using a 21mm wrench tighten the upper ball joint and a 24mm wrench tighten the lower ball joint.
48. Slide the CV axle shaft in the knuckle and tighten with stock nut and using a 13mm wrench. Reinstall the CV shafts on the differential with the factory hardware and using a 12mm 12 point socket. Install the outer dust cap.
49. Install ABS wire back into bearing using a 5mm allen wrench then install rotor and brake caliper with factory hardware using a 18mm wrench to tighten bolts . Reroute line as shown in **Photo 40** and install vacuum hose.

**PHOTO 39**



**Remove the dust shield**

**PHOTO 40**



**Reroute the line as needed**

50. Using a 10mm wrench remove the brake line bracket from the frame as shown in **Photo 41**. Replace the front brake lines with the new supplied brake lines/crush washers using 14mm,16mm and a 11mm wrench. Bleed the brakes and check brake fluid level. Reinstall brake line brackets with the factory hardware in the stock location.
51. Flip the tie-rod end and install into the knuckle using a 21mm wrench to tighten. **See Photo 42.**
52. If optional kicker bars were purchased with this kit, install at this time per the instructions included with that kit.
53. Install tires and wheels and lower to the ground. Tighten the lower control arm bolts.

**PHOTO 41**



**Remove the brake line from the frame rail**

**PHOTO 42**



**Install the tie rod on the knuckle**



## REAR INSTALLATION

1. Chock the front tires and jack the rear the rear end up. Put jack stand under the frame rail and lower truck onto jack stands.
2. Remove tires and wheels.
3. Remove rear shocks from the upper and lower mount using 18mm and a 15mm wrench. **See Photo 1 & 2.**

PHOTO 1

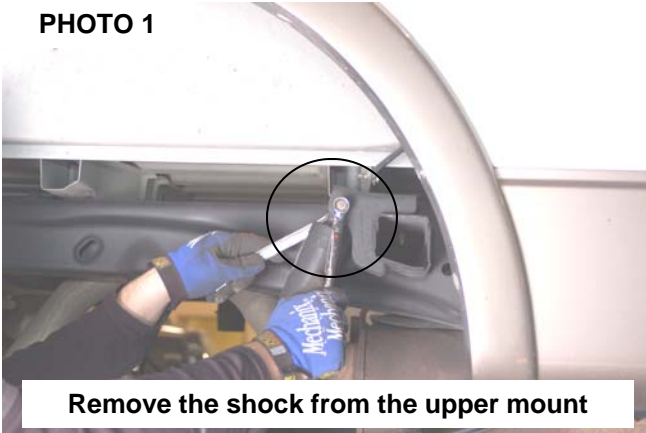

Remove the shock from the upper mount

PHOTO 2

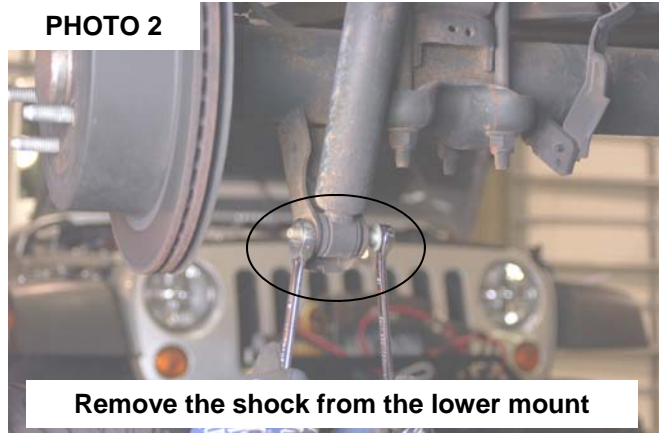

Remove the shock from the lower mount

4. Using a jack support the rear end on one side and remove U-bolts using a 21mm socket. **See Photo 3.** Retain the factory block.
5. Remove the e-brake cable from the factory e-brake bracket.
6. Remove the stock driver side emergency brake cable bracket **if so equipped** using 10mm wrench, 1" 1/16 and a 15/16 wrench. **See Photo 4.** Disconnect the e-brake cable from the main cable and discard stock bracket if so equipped.

PHOTO 3

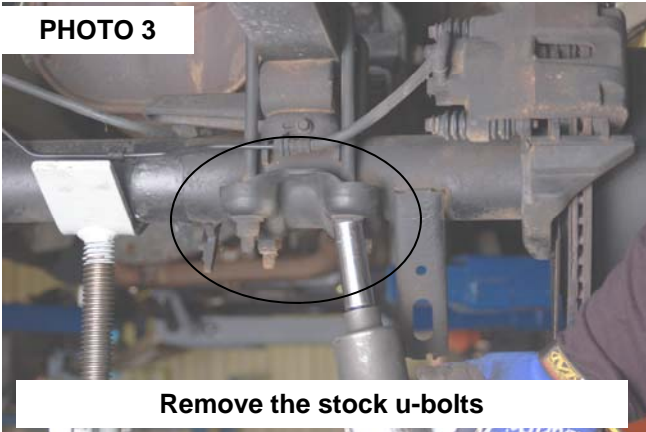

Remove the stock u-bolts

PHOTO 4

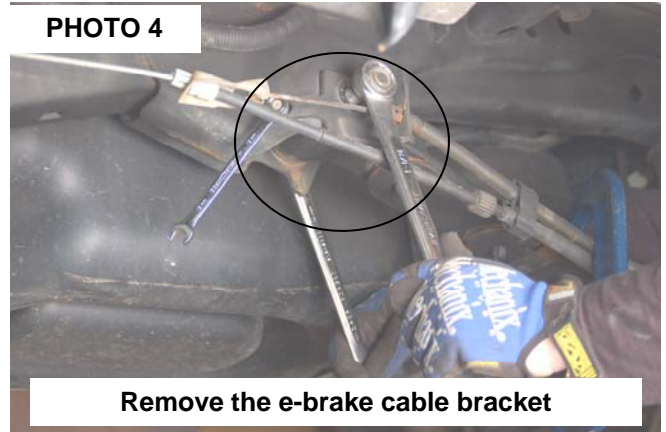

Remove the e-brake cable bracket

7. On some models it will be necessary to mark and drill the holes. If needed drill using a 11/32" bit as shown. **See Photo 5.**
8. Reinstall the e-brake cable into the new brackets using factory hardware and 5/16" x 1" bolt, washer & nut. Tighten factory bolts and new bolts using 24mm and 13mm wrench and reconnect the e-brake cable as shown. It may be necessary to slightly bend the clip on the e-brake cable to ensure the cable remains on the bracket. **See Photo 6.**

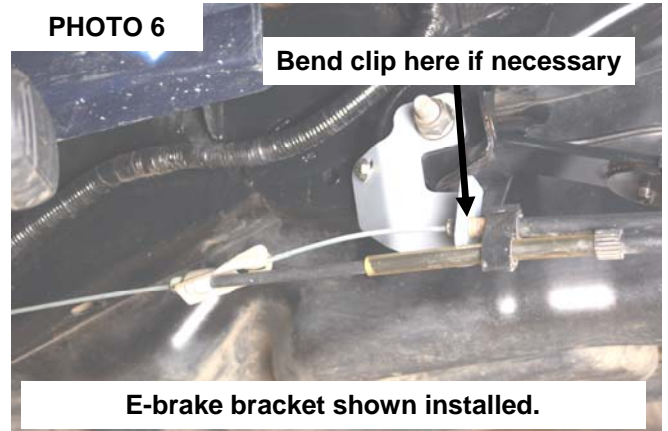
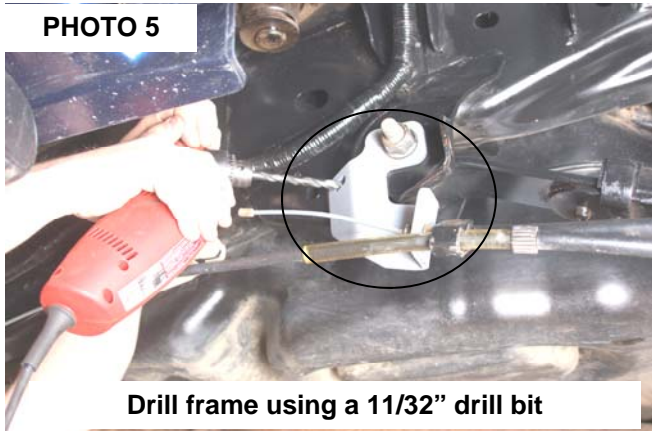

9. Install new block as shown in **Photo 7** with the stock block on top of the new block. Raise the axle using the jack until axle pins line up with hole and pin in block.
10. Secure block to axle and spring installing the 9/16 x 11" square U-bolts as shown. Tighten nuts to factory torque using a 7/8" socket. **See Photo 8.**

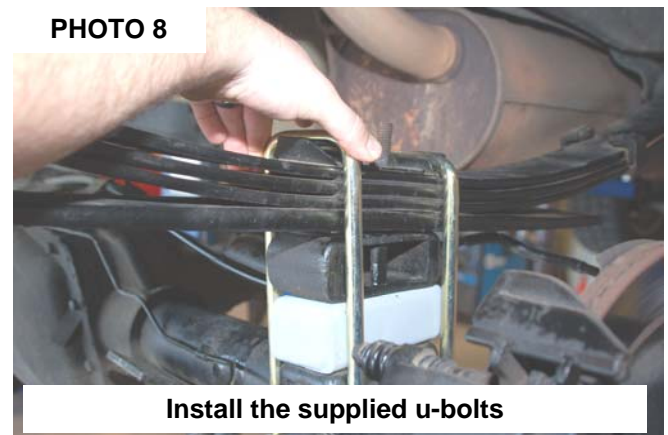

11. Install the bushing and sleeves into the shocks and install on the truck with factory hardware. Tighten using 15mm and a 18mm wrench. **See Photo 9.**





12. Remove the stock rear brake line bracket from the frame using a 10mm wrench. **See Photo 10.** Install the new brake line bracket on the drivers side frame rail in the stock mount with factory hardware and install the stock brake line bracket to the new bracket with the supplied 5/16" x 3/4" bolt/washers & nut. Remove the stock diff hose from the stock mount and install into the new bracket. **See Photo 11.**

**PHOTO 10**



**PHOTO 11**

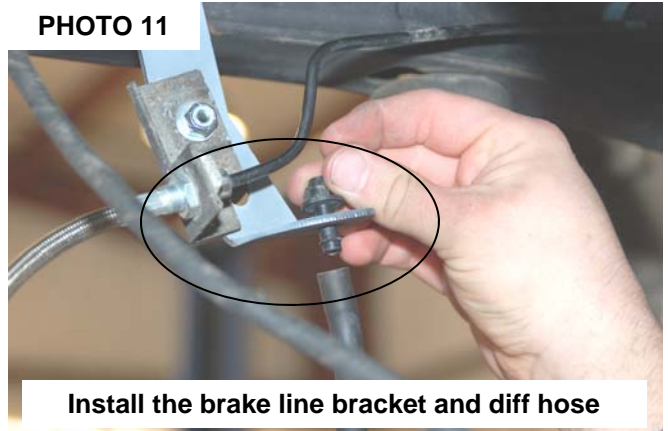

13. Install the wheels and tires.  
14. Jack up the vehicle and remove the jack stands. Lower the vehicle to the ground with floor jack.

## FRONT DRIVESHAFT RECLOCKING INSTRUCTIONS

Driveshaft modification will need to be performed if the vehicle experiences a driveshaft vibration . The reason for this vibration is that the factory driveshaft u-joints are not aligned from the factory. The next steps will allow the yoke to be turned on the driveshaft, thus eliminating the factory vibration. Normally this vibration is only felt when the vehicle is in 4wd at speeds in excess of 40mph.

1. Mark the driveshaft as shown in **Photo 1**. and Unclamp the boot on the driveshaft as shown in **Photo 2**.

**PHOTO 1**

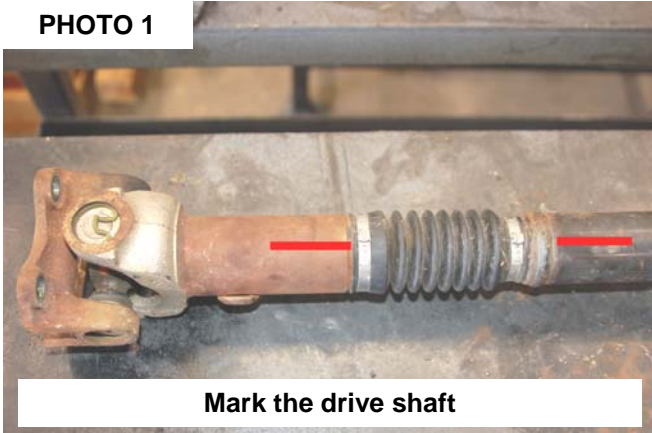

**PHOTO 2**

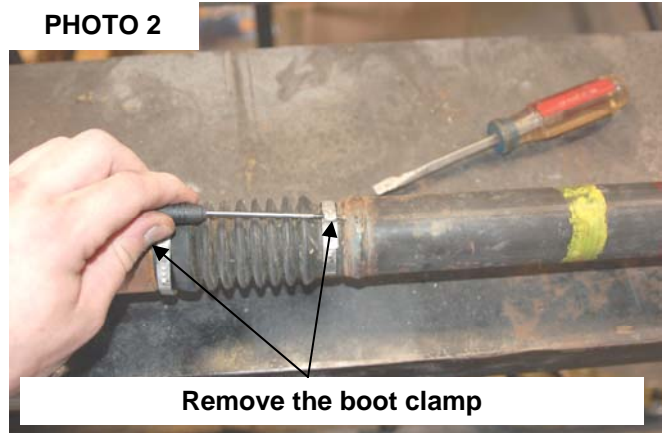

2. Remove the stock clamps and driveshaft boot and separate the driveshaft. Locate the tab on the driveshaft splines to be grooved. **See Photo 3**.
3. Groove the shaft as shown with die grinder as shown in **Photo 4**.

**PHOTO 3**



**PHOTO 4**



4. The finished groove is shown and will be the same as the rest of the grooves.
5. Reinstall the driveshaft yoke 90 degrees from where it was factory. This will align the u-joints. Make sure the u-joints are aligned before assembling the shaft.
6. Re-clamp the boot on the driveshaft with the factory clamps and using a clamping tool.

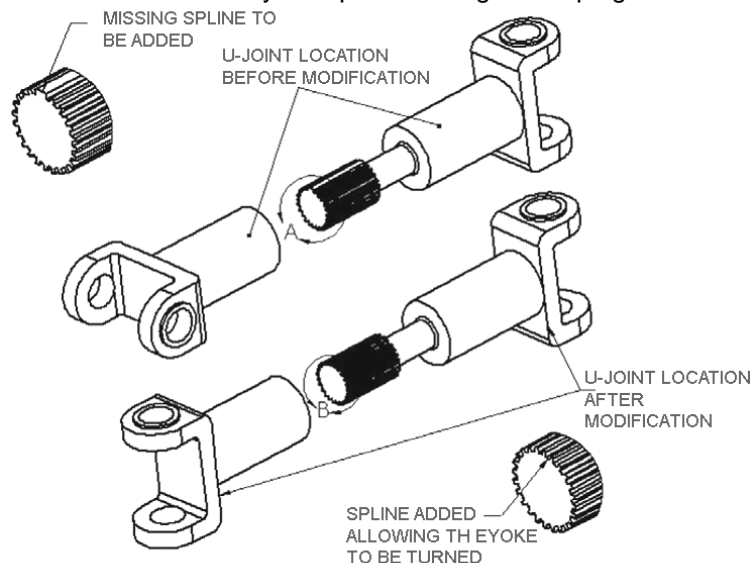



# DRILLING TEMPLATE

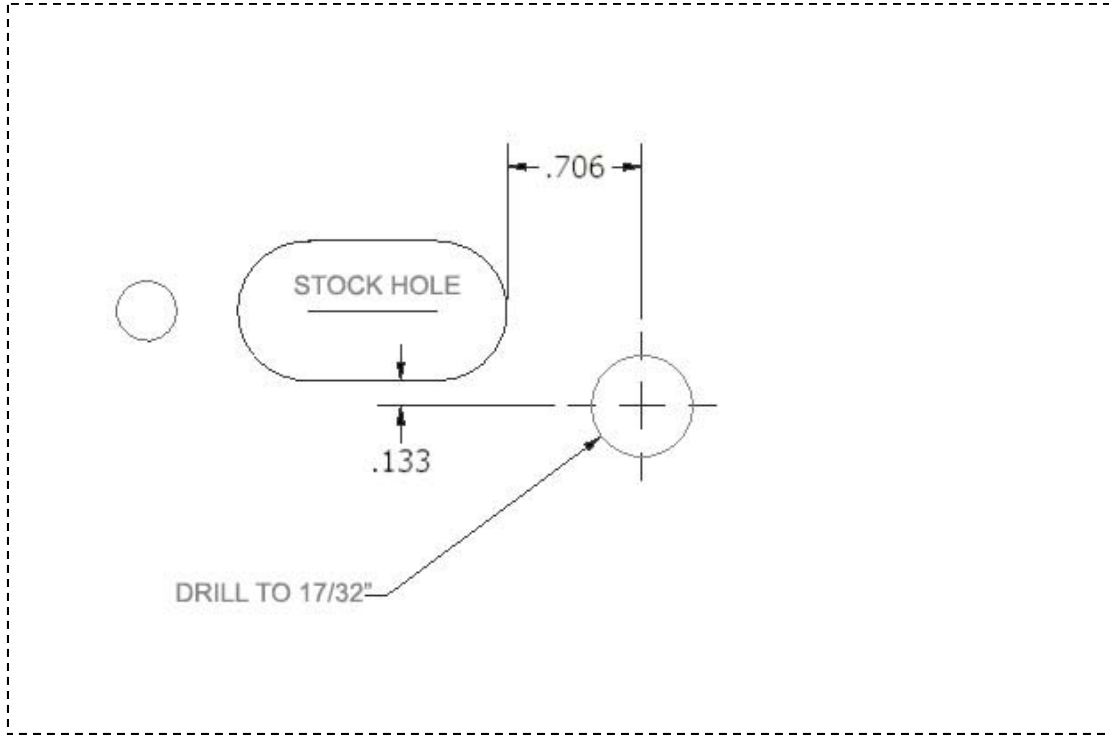

## POST INSTALLATION INSTRUCTIONS

1. Check all fasteners for proper torque. Check to ensure there is adequate clearance between all rotating, mobile, fixed and heated members. Check steering gear for interference and proper working order. Test brake system
2. Perform steering sweep. Check to ensure brake hoses have sufficient slack and will not contact rotating, mobile, or fixed members, adjust lines/brackets to eliminate interference and maintain proper working order. Failure to perform inspections may result in component failure
3. Readjust headlights to factory settings
4. Have vehicle aligned by a certified alignment professional.
5. Re-torque all nuts, bolts, and especially u-bolts after the first 100 miles, again after another 100 miles and then check periodically thereafter
6. All components must be retightened after 500 miles, and every three thousand miles after installation.
7. Rough Country recommends not operating the vehicle in 4 wheel drive above 40 mph. Doing so may result in a low frequency front driveshaft vibration. If vibration does occur please refer to included instructions in this sheet to re-lock the driveshaft.

**ROUGH COUNTRY ALSO OFFERS A KICKER BAR OPTION FOR THIS KIT. PART#1576BOX6. PLEASE CALL  
ROUGH COUNTRY OR YOUR LOCAL DEALER FOR MORE INFORMATION**



**THANK YOU FOR CHOOSING ROUGH COUNTRY FOR YOUR SUSPENSION NEEDS**

**PLEASE VISIT OUR WEBSITE @ [www.roughcountry.com](http://www.roughcountry.com) FOR YOUR OFF ROAD VEHICLE NEEDS**

**ROUGH  
COUNTRY**  
SUSPENSION SYSTEMS