

INSTALLATION GUIDE

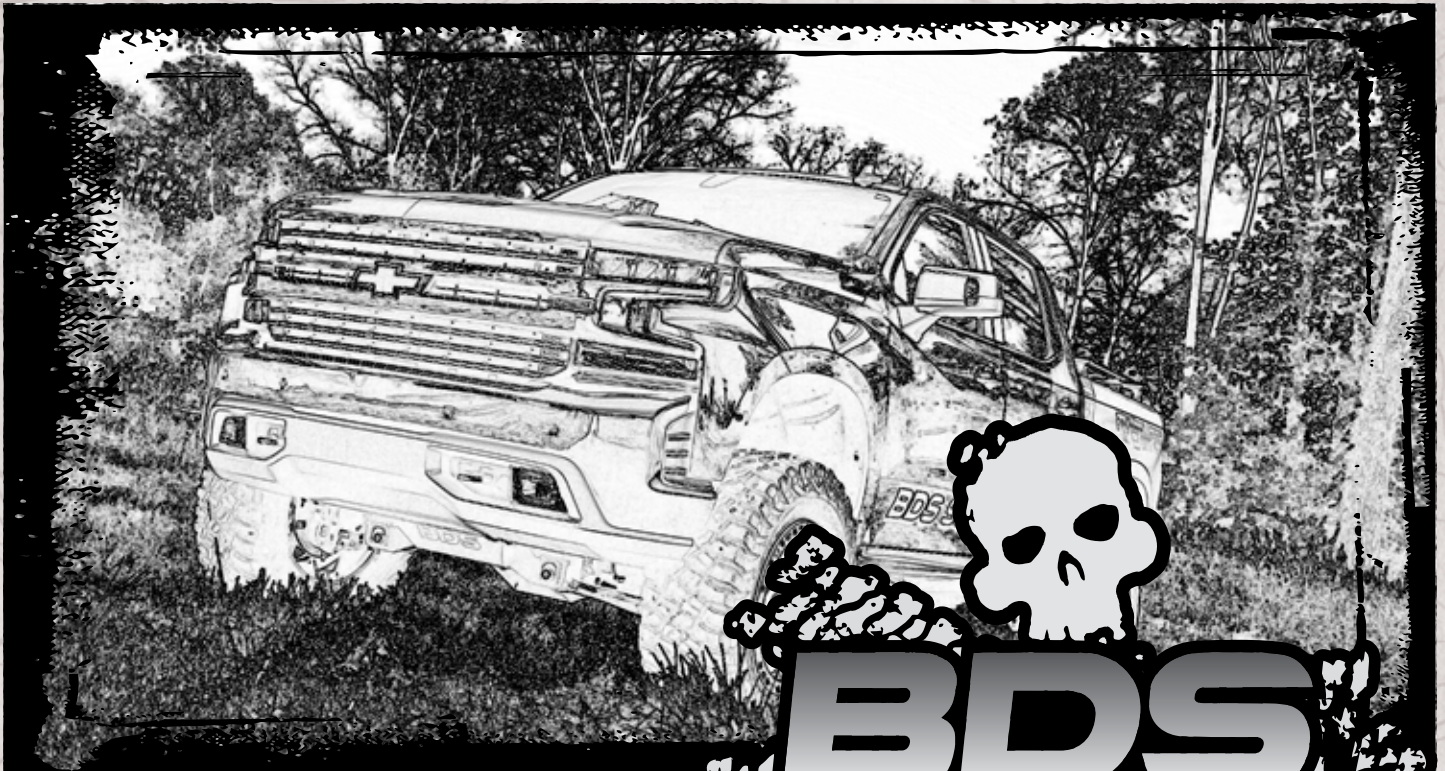

Part#: 021683

HARDCORE LIMITED LIFETIME WARRANTY

6" Suspension Systems

Chevy/GMC 1500 4WD Pickup | 2019+

Rev. 121418

491 W. Garfield Ave., Coldwater, MI 49036 • Phone: 517-279-2135
E-mail: tech-bds@ridefox.com

Read And Understand All Instructions And Warnings Prior To Installation Of System And Operation Of Vehicle.

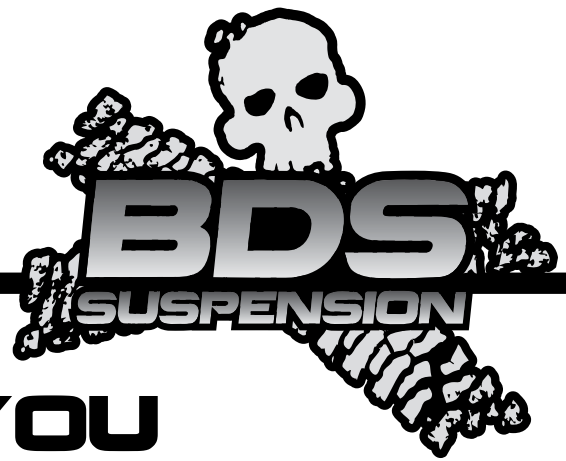

THANK YOU

Your truck is about to be fitted with the best suspension system on the market today. That means you will be driving the baddest looking truck in the neighborhood, and you'll have the warranty to ensure that it stays that way for years to come. Thank you for choosing BDS Suspension!

BEFORE YOU START

BDS Suspension Co. recommends this system be installed by a professional technician. In addition to these instructions, professional knowledge of disassembly/ reassembly procedures and post installation checks must be known.

FOR YOUR SAFETY

Certain BDS Suspension products are intended to improve off-road performance. Modifying your vehicle for off-road use may result in the vehicle handling differently than a factory equipped vehicle. Extreme care must be used to prevent loss of control or vehicle rollover. Failure to drive your modified vehicle safely may result in serious injury or death. BDS Suspension Co. does not recommend the combined use of suspension lifts, body lifts, or other lifting devices. You should never operate your modified vehicle under the influence of alcohol or drugs. Always drive your modified vehicle at reduced speeds to ensure your ability to control your vehicle under all driving conditions. Always wear your seat belt.

BEFORE INSTALLATION

Special literature required: OE Service Manual for model/year of vehicle. Refer to manual for proper disassembly/reassembly procedures of OE and related components.

Adhere to recommendations when replacement fasteners, retainers and keepers are called out in the OE manual.

Larger rim and tire combinations may increase leverage on suspension, steering, and related components. When selecting combinations larger than OE, consider the additional stress you could be inducing on the OE and related components.

Post suspension system vehicles may experience drive line vibrations. Angles may require tuning, slider on shaft may require replacement, shafts may need to be lengthened or trued, and U-joints may need to be replaced.

Secure and properly block vehicle prior to installation of BDS Suspension components. Always wear safety glasses when using power tools.

If installation is to be performed without a hoist, BDS Suspension Co. recommends rear alterations first.

Due to payload options and initial ride height variances, the amount of lift is a base figure. Final ride height dimensions may vary in accordance to original vehicle attitude. Always measure the attitude prior to beginning installation.

BEFORE YOU DRIVE

Check all fasteners for proper torque. Check to ensure for adequate clearance between all rotating, mobile, fixed, and heated members. Verify clearance between exhaust and brake lines, fuel lines, fuel tank, floor boards and wiring harness. Check steering gear for clearance. Test and inspect brake system.



Visit 560plus.com for more information.

TRACTION CONTROL

In an effort to reduce the risk of rollover crashes the National Highway Traffic Safety Administration (NHTSA) established the Federal Motor Vehicle Safety Standard (FMVSS) No. 126 requiring all new passenger vehicles under 10,000 lbs GVWR include an electronic stability control (ESC) system as standard equipment. Effective August 2012 this law requires aftermarket products to be compliant with these same standards.



TIRES AND WHEELS FITMENT GUIDE

Chevy

35" x 12.50 on 17x8, 17x9, 18x9 w/4.5" BS
35" x 12.50 on 20x9 or 22x9 w/4.5"-6.25" BS
37" x 12.50 on 20x9 or 22x9 w/ 5.5"- 6.25" BS

GMC

295/70 on 17x8, 17x9, 18x9 w/4.5" BS
295/65 on 20x9 w/4.5"-6.25" BS
35" x 12.50 on 20x9 or 22x9 w/5.5"-6.25" BS
*See troubleshooting notes
*Trimming may be required



Perform steering sweep to ensure front brake hoses have adequate slack and do not contact any rotating, mobile or heated members. Inspect rear brake hoses at full extension for adequate slack. Failure to perform hose check/ replacement may result in component failure. Longer replacement hoses, if needed can be purchased from a local parts supplier.

Perform head light check and adjustment.

Re-torque all fasteners after 500 miles. Always inspect fasteners and components during routine servicing.

CONTENTS OF YOUR KIT

021680 - DRV Knuckle Box Kit

021681 - PASS Knuckle Box Kit

| Part # | Qty | Description |
|----------|-----|---------------------------------------|
| 03613 | 1 | Steering Knuckle - DRV (021680 only) |
| 03614 | 1 | Steering Knuckle - PASS (021681 only) |
| 401-2039 | 2 | Tie Rod End |

021682 Box Kit

| Part # | Qty | Description |
|--------|-----|------------------------------------------------|
| 03615 | 1 | Front Crossmember |
| 03616 | 1 | Rear Crossmember |
| A310 | 1 | Sway Bar Drop - DRV |
| A311 | 1 | Sway Bar Drop - PASS |
| 03619 | 1 | Diff Drop - DRV |
| 03620 | 1 | Diff Drop - PASS |
| 03621 | 1 | Diff Drop Brace - PASS |
| 849 | 1 | Bolt Pack - Control Arm/ Crossmember |
| | 8 | M18 x 2.5 Prevailing Torq Nut - Clear Zinc |
| | 8 | 3/4 SAE Thru Hard Flat Washer - Clear Zinc |
| | 2 | 18mm-2.50 x 120mm Class 10.9 Bolt - Clear Zinc |
| | 2 | 18mm-2.50 x 130mm Class 10.9 Bolt - Clear Zinc |

021684 Strut Spacer Box Kit

| Part # | Qty | Description |
|--------|-----|--------------------------------------------|
| 03624 | 2 | 6" Strut Spacer |
| 629 | 1 | Bolt Pack |
| | 6 | 10mm-1.50 prevailing torque nut clear zinc |
| | 6 | 3/8" USS flat washer clear zinc |

011518 Rear Box Kit

| Part # | Qty | Description |
|-------------|-----|---------------------------------------------|
| 03669 | 2 | Rear Block |
| 962961212QB | 4 | 9/16 x 2-9/16 x 12-1/2 Square U-bolt |
| 3396 | 2 | Bump Stop Spacer |
| 03578 | 2 | Leaf Spring U-bolt Plate |
| 380412FCP | 2 | Center Pin |
| 03667 | 1 | Rear ABS BRKT |
| 03668 | 1 | Rear Brake Line BRKT |
| N96FH-B | 8 | 9/16 Fine High Nut- Black |
| W96S-B | 8 | 9/16 SAE Flat Washer-Black |
| 848 | 1 | Bolt Pack |
| | 2 | 10mm-1.50 x 100mm Allen head bolt |
| | 2 | 1/4"-20 x 1" Bolt - Grade 5 - Clear Zinc |
| | 2 | 1/4"-20 Prevailing Torque Nut - Clear Zinc |
| | 4 | 1/4" SAE Washer - Clear Zinc |
| | 2 | 5/16"-18 x 1" Bolt - Grade 5 - Clear Zinc |
| | 2 | 5/16"-18 Prevailing Torque Nut - Clear Zinc |
| | 4 | 5/16" SAE Washer - Clear Zinc |

021683 Box Kit

| Part # | Qty | Description |
|--------|-----|--------------------------------------------------|
| 02175B | 1 | Differential Skid Plate - DRV |
| 03626 | 1 | Differential Skid Plate - PASS |
| 03646 | 1 | Front Skid Plate |
| 03673 | 1 | ABS Bracket - DRV |
| 03674 | 1 | ABS Bracket - PASS |
| 03627 | 1 | Weld In Plate |
| 099000 | 7 | 11.5in Nylon Cable Tie - Black |
| 142 | 1 | .875x3.268 Sleeve |
| 03444 | 2 | CV Spacer |
| 342701 | 1 | Thread Locker |
| 02001 | 8 | Eccentric Cam |
| 03623 | 4 | Eccentric Cam Bolt |
| 03622 | 1 | Passenger Side Diff Mount Spacer |
| 846 | 1 | Bolt Pack - Diff Drop |
| | 3 | 9/16"-12 x 4" Bolt - Grade 8 - Yellow Zinc |
| | 1 | 9/16"-12 x 1-3/4" Bolt - Grade 8 - Yellow Zinc |
| | 8 | 9/16" SAE Washer - Yellow Zinc |
| | 4 | 9/16"-12 Prevailing Torque Nut |
| | 1 | 14mm-2.00 x 120mm Bolt - Class 10.9 - Clear Zinc |
| | 1 | 14mm Washer - Clear Zinc |
| | 1 | 1/2"-13 x 5" Bolt - Grade 8 - Yellow Zinc |
| 422 | 1 | Bolt Pack |
| | 4 | 3/8"-16 x 1-1/4" bolt grade 8 yellow zinc |
| | 4 | 3/8"-16 prevailing torque nut yellow zinc |
| | 8 | 3/8" USS flat washer thru-hardened yellow zinc |
| 847 | 1 | Bolt Pack - Skid Plate & Knuckle |
| | 6 | Wire Clamp |
| | 7 | 6mm-1.00 x 12mm Bolt - Class 8.8 - Clear Zinc |
| | 7 | 1/4" SAE Washer - Clear Zinc |
| | 8 | 1/2"-13 x 1-1/4" Bolt - Grade 8 - Yellow Zinc |
| | 2 | 1/2"-13 x 4" Bolt - Grade 8 - Yellow Zinc |
| | 12 | 1/2" SAE Washer - Yellow Zinc |
| | 2 | 1/2"-13 Prevailing Torque Nut - Yellow Zinc |

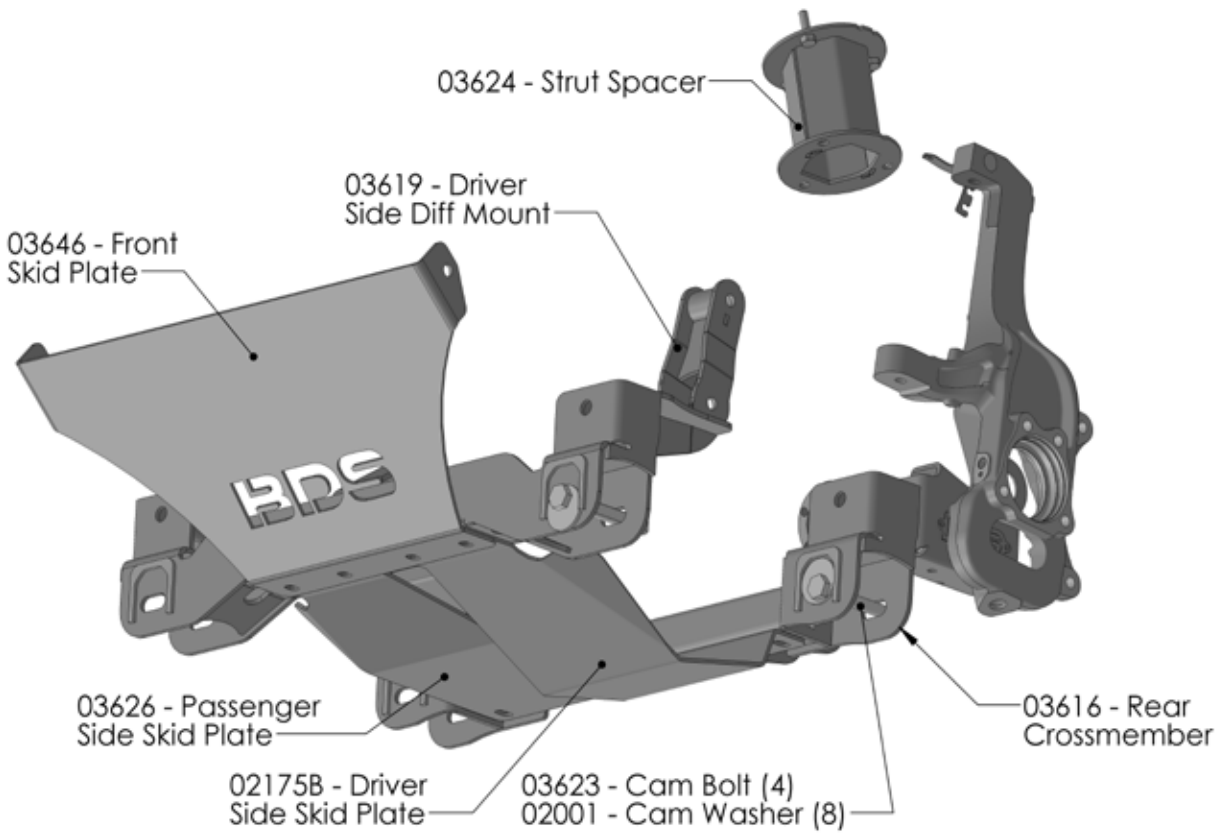
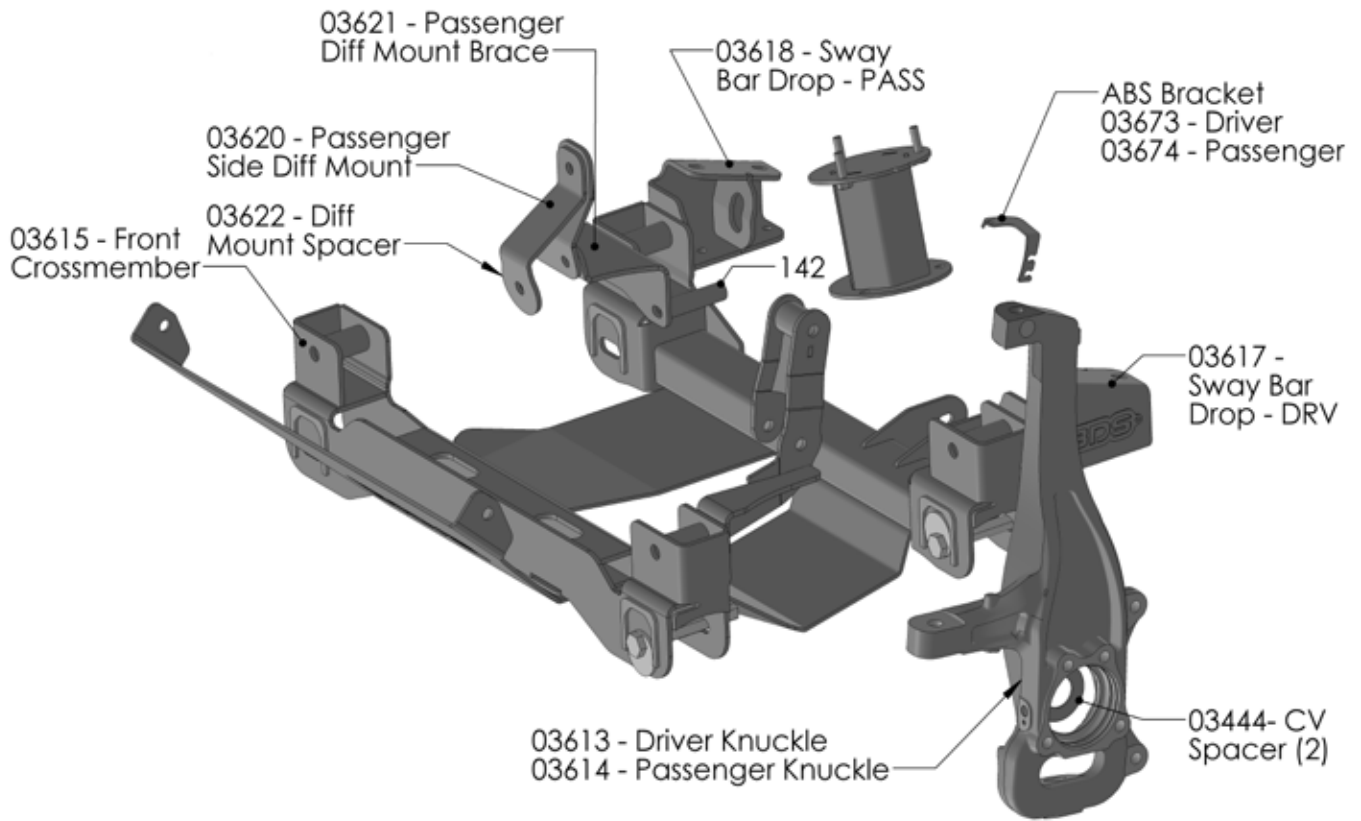



TROUBLESHOOTING INFORMATION FOR YOUR VEHICLE

1. Requires frame bracket modification and welding.
2. All aftermarket wheels should be test fit prior to mounting the tire to ensure proper clearance to the brake caliper. Some wheel profiles will not clear the brake caliper. These can be test fitted before the vehicle is lifted.
3. 17" wheels with 4.5" backspacing should be test fit prior to mounting the tire to ensure proper clearance to the steering knuckle/tie rod.
4. Stock 20" Wheels (6.25" Backspacing) can be installed, stock 17" or 18" Wheels CAN NOT be installed.
5. Will NOT work with MagneRide / Adaptive Ride Equipped Vehicles.
6. Will NOT work with TrailBoss or AT4 Models.
7. O-rings in factory steering knuckle will be reused. Take care not to damage O-rings on disassembly and assembly
8. When disassembling the steering knuckle from the truck, be careful not to drop the CV shaft on to the top of the lower ball joint. The top of the lower ball joint has very sharp edges that can cut the CV boot.

**TECH
TIPS**

INSTALLATION INSTRUCTIONS

MEASURE FIRST

Measure from the center of the wheel up to the bottom edge of the wheel opening:

LF _____ RF _____

LR _____ RR _____

WELDING IS REQUIRED

The installation of this kit requires minor welding of a reinforcement plate. We recommend this procedure be performed by an experienced welder. If necessary, this kit can be completely installed and then driven to a shop to have the plate welded. This method will make reaching the weld locations slightly more difficult but it can be done if necessary.

FRONT DISASSEMBLY

1. Park the vehicle on a clean, flat surface and block the rear wheels for safety.
2. Disconnect the positive and negative battery cables from the battery.

SPECIAL TOOLS

36mm Socket - Hub Nut
 Reciprocating Saw or Cut Off Wheel & Grinder
 Welder
 C-Clamps (2)

3. Raise the front of the vehicle with a hydraulic jack and support the frame with jack stands. Remove the wheels.



Tip *If an impact wrench is not being used, the CV axle nut will need to be removed with the weight of the vehicle on the wheel.*

4. Remove the ABS line and brake sensor from the retaining clips at the frame, upper control arm and knuckle. Disconnect the brake line bracket from the steering knuckle (Fig. 1). Save bolt.

FIGURE 1A



FIGURE 1B



5. Remove the ABS sensor from the steering knuckle (Fig. 2).

FIGURE 2



6. Remove the splash guard from the vehicle (Fig. 3).

FIGURE 3



7. Remove the tie rod end nut. Disconnect the tie rod from the knuckle (Fig. 4). **Aluminum Knuckle:** Avoid striking the knuckle, typically the taper unseats more easily and gently hitting the end of the tie rod end will unseat the taper. A pickle fork can also be used. Save the mounting nut.

FIGURE 4



8. Remove the two brake caliper mounting bolts and remove the caliper from the knuckle (Fig. 5). Hang the caliper securely out of the way DO NOT hang the caliper by the brake hose. Save caliper bolts.

FIGURE 5

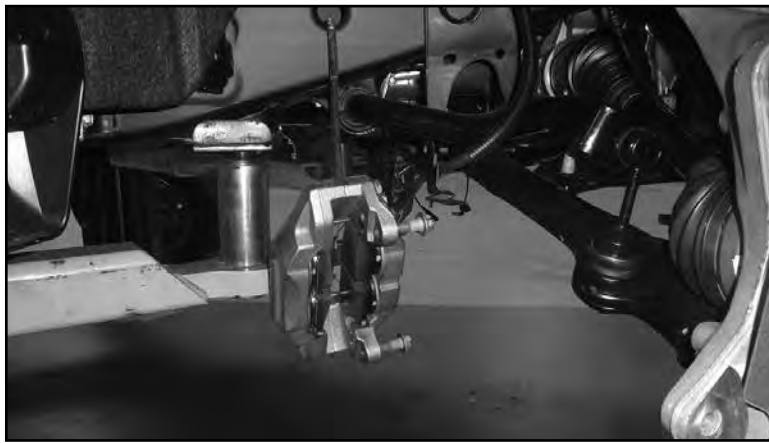

9. Remove the brake rotor retaining bolt and remove the rotor from the vehicle.
10. Remove and retain the axle shaft nut. (Fig. 6)



Tip *The axle nut will require a 36mm socket.*

FIGURE 6



11. Remove the sway bar links nut from the the lower control arms (Fig. 7). Save the hardware.

FIGURE 7

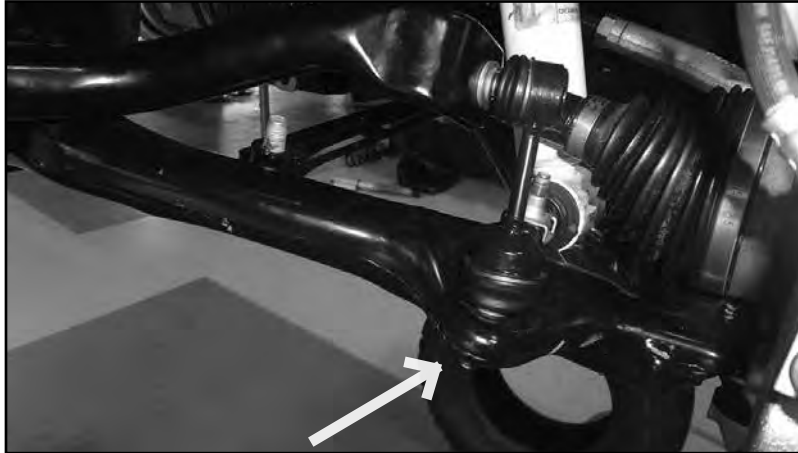

12. Mark the orientation of the sway bar and remove it from the frame by removing the four bushing cap mounting bolts (Fig. 8). Save all sway bar components, the hardware can be discarded..



Tip Mark *D* and *P* on the sway bar to indicate driver and passenger side for orientation when reinstalling the sway bar.

FIGURE 8

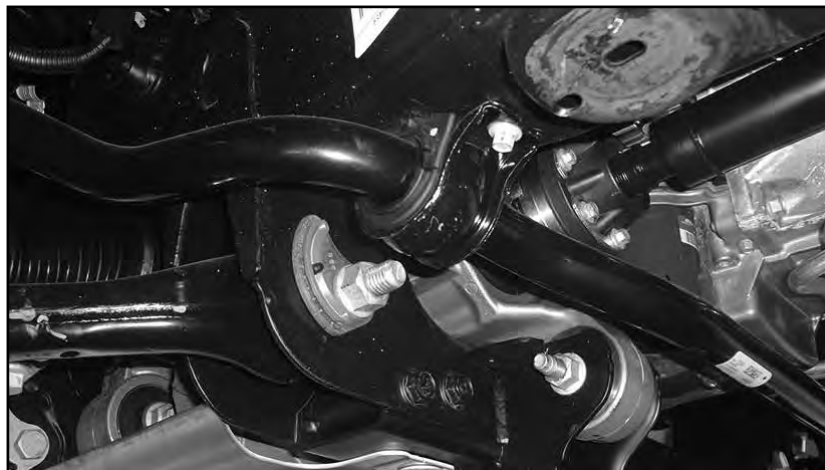

13. Remove the upper and lower ball joint nuts and thread back on by hand a couple of turns. **Aluminum Knuckles:** Avoid striking the knuckle to release the taper, a pickle fork or pry bar can be used to apply a splitting force. Gently hit the end of the ball joint to get it to release. If you do resort to hitting the knuckle avoid re-use and discard.

FIGURE 9



FIGURE 10



14. Mark each of the front strut bodies to indicate driver's versus passenger's side.
15. Support the lower control arm with a jack. Remove the upper ball joint nut and the lower strut mount bolts (Fig. 11). Save bolts. Swing the knuckle / lower control arm down to remove the CV shaft from the hub. Retain ball joint nut and strut bolts.

FIGURE 11



16. Remove the lower ball joint nut and remove the knuckle from the vehicle. Retain hardware.
17. Remove the front and rear lower control arm mounting bolts and remove the lower control arm from the vehicle. Save mounting hardware and control arms.
18. Remove the three upper strut mounting nuts (Fig. 12) and remove the strut from the vehicle. DO NOT remove the center strut rod nut, it is under extreme pressure. Save nuts.

FIGURE 12

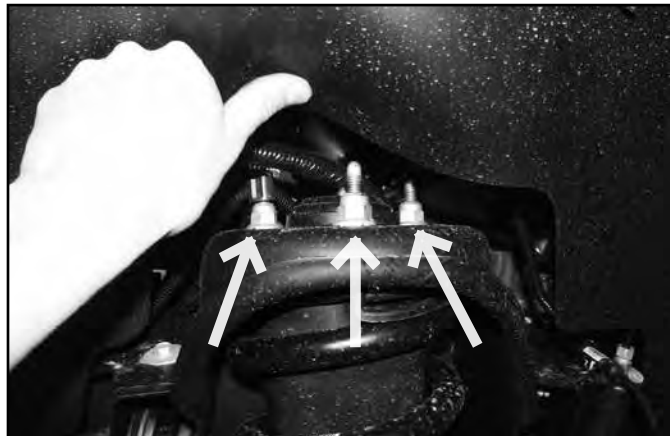

19. Make an alignment mark to show the relationship between the front driveshaft and the differential yoke. Remove the six driveshaft bolts and disconnect the driveshaft from the differential. Save bolts. (Fig. 13)

FIGURE 13



20. Remove the bolt attaching the differential to the rear crossmember (Fig. 14). The hardware will not be reused.

FIGURE 14



21. Remove the factory rear crossmember from the vehicle by removing the 4 bolts. (Fig 15) Crossmember and hardware will not be reused.

FIGURE 15



22. Disconnect the differential actuator wire connector from the actuator (Fig. 16).



Tip *If you are having difficulty accessing the plug, wait until the differential is being lowered to disconnect it.*

FIGURE 16

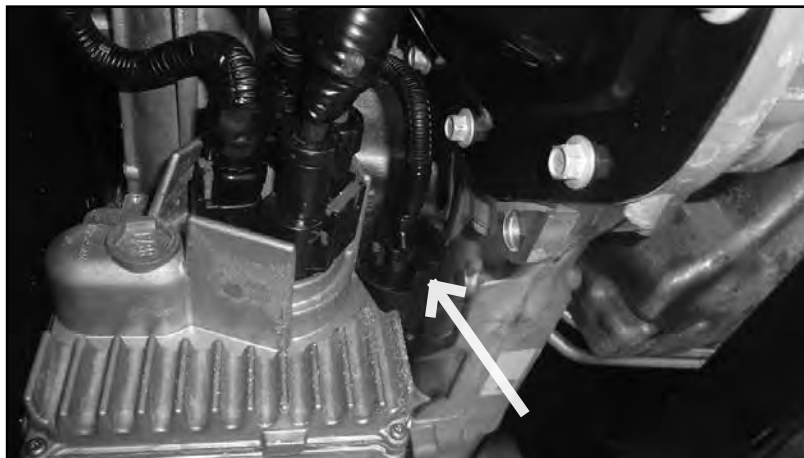

23. Disconnect the differential breather hose (Fig. 17).



Tip *The differential may need to be lowered a little bit to disconnect the breather hose. This can be done as the differential is being removed.*

FIGURE 17 - SHOWN WITH DIFFERENTIAL REMOVED FOR CLARITY



24. Support the front differential with an appropriate jack. Remove the driver's side differential mounting bolts (Fig. 18). Save mounting bolt hardware.



Tip We highly recommend having an assistant to help with removal of the front differential.

FIGURE 18



25. Remove the nut from the passenger's side differential mounting bolt (Fig. 19A). Carefully lower the differential to the ground while removing the long bolt for the passenger's side differential mount (Fig. 19B).



Tip The bolt holding the actuator may need to be removed in order to aid in removal of the long bolt for the differential. The bolt is on the right side in Figure 22B. Reinstall the bolt for the actuator after it has been removed. It also helps to push the rear of the differential upwards to point the bolt head downwards to aid in removal.

FIGURE 19A



FIGURE 19B



26. The driver's side rear lower control arm pocket must be cut to provide clearance for the front differential in the relocated position. This area needs to be cleaned of any oil, grease and/or undercoating. These coatings are flammable.



Tip A putty knife and parts cleaning solvent work well to remove undercoating.

27. Measure from the inside of the driver's side rear control arm pocket out 2-9/16" and mark (Fig. 20A). Repeat this measurement on the opposite side of the pocket. Make vertical cut lines at the 2-9/16" mark up both front and back faces of the pocket (Fig. 20B).

FIGURE 20A



FIGURE 20B

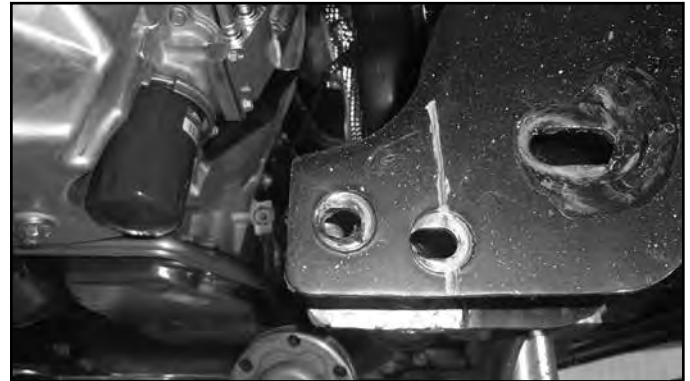

28. Make a vertical cut along each of the cut lines on the front and back faces of the control arm pocket with a reciprocating saw (recommended), cut-off wheel or plasma cutter. Be careful, the undercoating on the frame is flammable and can melt and drip off the frame. Keep a fire extinguisher near by.
29. With the vertical cuts complete, cut the top portion of the pocket by connecting the two cuts.
30. The bottom front of the rear lower control arm pockets must be cut to provide clearance for the rear crossmember. This area needs to be cleaned of any oil, grease and/or undercoating. These coatings are flammable.



Tip A putty knife and parts cleaning solvent work well to remove undercoating.

31. Measure down 1-3/8" from the bottom edge of the rear control arm bolt hole on both the driver and passenger sides (Fig. 21A & C). The passenger side will also have a vertical cut 1-3/4" in from the edge of the pocket as shown in Figure 21B & D.

Note: This will only need to be done on the front of the rear lower control arm pocket. On the passenger side do NOT cut out the inner most slot as shown in Figure 21D.

FIGURE 21A

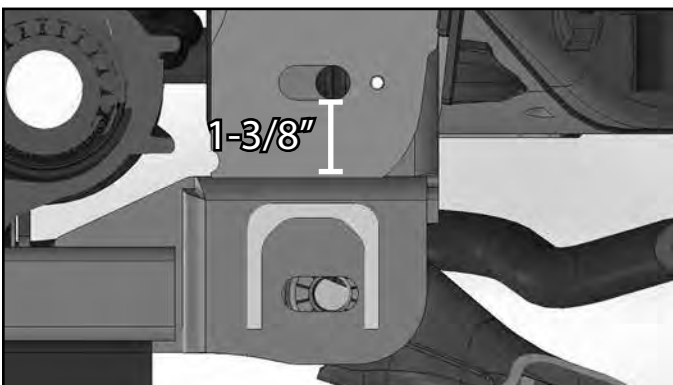

FIGURE 21B

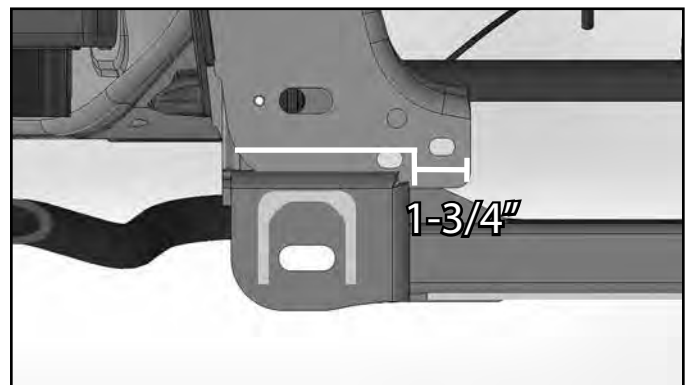

FIGURE 21C



FIGURE 21D



32. The bottom front of the front lower control arm pockets must be cut to provide clearance for the front crossmember. This area needs to be cleaned of any oil, grease and/or undercoating. These coatings are flammable.



Tip A putty knife and parts cleaning solvent work well to remove undercoating.

33. Make a line parallel with the bottom edge of the front lower control arm pocket as shown in Figure 22. Trim all the way to the inner edge of the lower control arm pocket.

Note: This will only need to be done on the front of the front lower control arm pocket. Additional grinding may be required on the lower control arm pocket for crossmember clearance.

FIGURE 22A

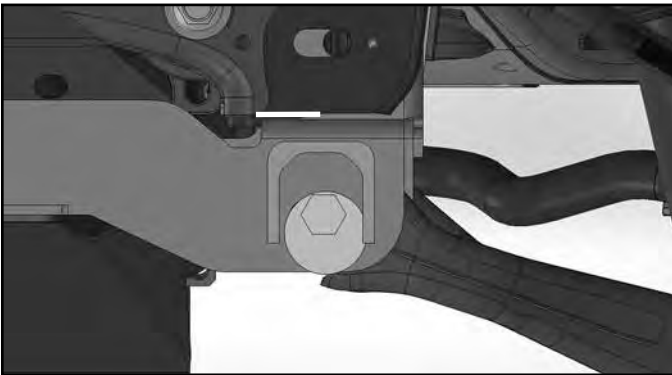

FIGURE 22B



FRONT INSTALLATION

34. Place the provided weld-in plate (03627) up against the cut edge of the control arm pocket. The plate should be flush with the bottom edge of the pocket and overhang the front and back outside surfaces an equal amount. (Fig. 23). Tack weld the plate in place.



Tip Welding should be performed by an experienced welder. Ensure the battery has been disconnected prior to welding. See pre-installation notes at the beginning of these instructions.

FIGURE 23 - SHOWN ALREADY PAINTED



35. With the plate tacked, go back and weld the plate in place. Weld along the OUTSIDE of the pocket on the vertical surfaces. Welding on the inside will result in crossmember interference. Weld along the top edge of the plate on the inside of the pocket. Once the area has cooled, paint all exposed metal to prevent corrosion.
36. Install the new driver's side differential bracket (03619) to the original mount with the factory long bolt (Fig. 24A). The bracket will line up with the alignment pin on the front control arm pocket (Fig 24B). Leave hardware loose.



Tip *Install the bracket onto the pin first before installing the bolt into the factory mount.*

FIGURE 24A



FIGURE 24B



37. Install the front crossmember (03615) in the control arm pockets with the the provided shorter 18mm bolt, prevailing torque nuts, and washers Run bolts from front to rear (Fig. 25). Leave hardware loose. Make sure to attach the differential bracket to the frame on the driver's side with the provided hardware.



Tip *The hardware for the crossmembers is located in bolt pack 849.*

FIGURE 25



38. Install the new passenger's side differential bracket (03620) to the original mounting location with the new 14mm bolt, 14mm washer, and factory nut (Fig. 26). Snug up hardware, but do not tighten.

 **Tip** The hardware for the differential drop is located in bolt pack 846.

FIGURE 26



39. Install the new passenger's side differential brace (03621) to the front of the rear control arm pocket. The bracket will mount to the alignment pin and into the slot from the factory rear crossmember. Attach to the passenger's side differential bracket with a 9/16" x 1-3/4" bolt, prevailing torque nut, and washers (Fig 27). Leave hardware loose.

FIGURE 27 - SHOWN WITH DIFFERENTIAL ALREADY INSTALLED

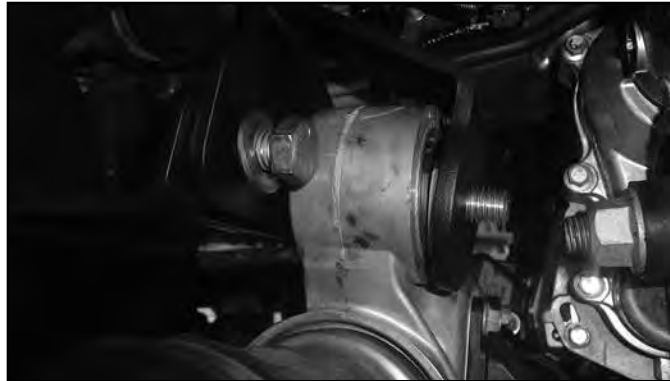

40. Install the provided sleeve through the slot on the factory rear crossmember location. Attach the differential brace to the frame with the provided 1/2" x 5" bolt, prevailing torque nut, and washers (Fig. 28). Leave hardware loose.

 **Tip** The hardware for the differential drop / spacer tube is located in bolt pack 846.

FIGURE 28



41. Install the differential to the new driver's and passenger's differential brackets. Loosely attach the differential to both differential drop brackets with 9/16" x 4" bolts, prevailing torque nuts, and washers (Fig 29C & D). The passenger's side differential bracket will use a spacer (03622) on the front side between the bushing and the differential bracket (Fig. 29A & B).

 **Tip** Run the passenger's side differential bolt from rear to front as shown in Figure 29D.

 **Tip** When installing the passenger's side differential mount install the spacer (03622; Figure 29B) with the differential into the slotted mount. The spacer takes up the gap created from the flange on the differential mount.

FIGURE 29A - SPACER SHOWN INSTALLED



FIGURE 29C- DRIVER SIDE



FIGURE 29B

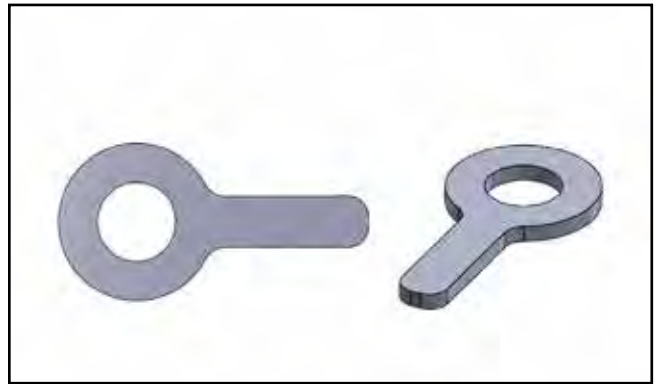
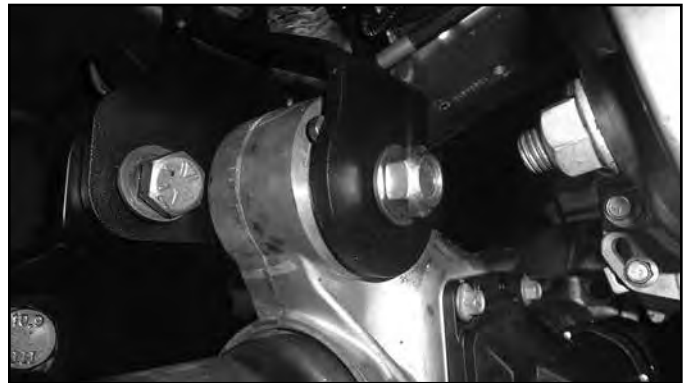

FIGURE 29D - PASSENGER SIDE



42. Install the new rear crossmember (03616) with the provided longer 18mm bolt, prevailing torque nuts, and washers. The tabs on the crossmember should align with the center diff. bracket. Run the bolts from front to rear. Leave hardware loose. Make sure the passenger's side bolt runs through the differential brace. (Fig. 30).

 **Tip** The bolts for the differential may need to be removed one side at a time in order to install the 18mm bolts for the rear crossmember. It is also possible with the differential hardware being loose to move the differential out of the way enough to install the 18mm crossmember bolts..

FIGURE 30



43. Install the 9/16" x 4" bolts, prevailing torque nuts, and washers in the rear crossmember and through the differential mount on the rear crossmember (Fig. 31). Leave hardware loose.

FIGURE 31



44. Reconnect the differential actuator wiring. Reattach the wire to the differential housing with the factory clips.
45. Reconnect the differential breather line. The line will need to be removed from retaining clips above to gain slack.



Tip *The breather line may need to be accessed through the engine compartment to be rerouted for more slack.*

46. Remove the nut and washer from the back side of the rear crossmember bolt. Install the sway bar drop brackets (A310 & A311) into the 18mm bolt for the rear crossmember. Reinstall the nut and washer for the rear crossmember bolt. Snug up the sway bar drop bracket to the frame with thread locker and the provided 10mm bolts and washers. Do not tighten the sway bar to frame bolts at this time. (Fig. 32A & B).



Tip *The hardware for the sway bar drop brackets are located in bolt pack 846. Thread locker will dry quickly, make sure up to step 49 is performed in a timely manner to prevent the thread locker from drying.*

FIGURE 32A



FIGURE 32B



47. Install the OE lower control arms in the new crossmembers with the provided 18mm cam bolts, cam washers, and 18mm prevailing torque nuts. Run the front bolts from front to rear. Run the rear bolts from rear to front. Leave hardware loose. The main body of the cam will be 'up' in the cam slot.

 **Tip** *The nuts for the lower control arms are located in bolt pack 849.*

48. Tighten all 18mm hardware for the front and rear crossmembers to 250 ft-lbs. Torque all differential mount hardware: 1/2" hardware to 65 ft-lbs, 9/16" & 14mm hardware to 90 ft-lbs. Torque the 10mm sway bar drop hardware to 45 ft-lbs.

 **Tip** *Center the cams for the lower control arms and snug up the nuts, but do NOT tighten the nuts at this time.*

49. Loosely attach the differential skid plates (03626 & 02175) to the rear crossmember with four 1/2" x 1-1/4" bolts and washers in the threaded holes in the crossmember.

 **Tip** *The hardware for the skid plates is located in bolt pack 847.*

50. Install the front skid plate (03646) to the frame holes with the provided 1/2" x 4" bolt, prevailing torque nut, and washers. Leave hardware loose (Fig. 33). The differential skid plates will sandwich between the front skid plate and front crossmember also using 1/2" x 1-1/4" bolts and washer. Use thread locker on all skid plate bolts to the crossmembers. Tighten all skid plate bolts to 65 ft-lbs (Fig. 33 & 34)

FIGURE 33



FIGURE 34



51. Install the provided strut spacers (03624) on the strut with the provided 10mm prevailing torque nuts and washers. The spacers will only install one way (Fig. 35). Torque hardware to 30 ft-lbs.

 **Tip** *The hardware for the strut spacers is located in bolt pack 629.*

FIGURE 35



52. Install the new strut assembly to the appropriate frame mount with the factory nuts. Leave hardware loose.
Note: Be sure that the strut is oriented properly in the vehicle.
53. Remove the hub bearing/rotor assembly and brake dust shield from the factory steering knuckles. Remove the two O-rings on the knuckle. Be sure to note which hub goes on which side of the vehicle. Save mounting bolts.
54. The brake dust shield needs to be trimmed on both the driver and passenger sides. Measure in from the lower vertical edge 1-1/4" and make a cut as shown in Figure 36A. The upper edge will need to be cut at a 45 degree angle as shown in Figure 36A on the upper right side. Figure 36 A & B show the cut to clear the brake caliper. The cuts will be mirror images on the driver side as to what is shown in the pictures.

 **Tip** Check for clearance to the brake caliper after installation.

FIGURE 36A - PASSENGER SIDE SHOWN



FIGURE 36B - PASSENGER SIDE SHOWN



55. Install the modified dust shield on the corresponding new knuckles. Install the two O-rings on the new knuckle. Fasten the hub/shield with the OE bolts. Apply thread locker to the bolt threads and torque to 133 ft-lbs.
56. Install the CV shaft spacer (03444) on the CV stub shaft with the chamfered edge facing towards the inside of the vehicle (Fig 37A). Install the assembled knuckle on the lower control arm and loosely fasten with the original lower control arm nut (Fig. 37A). Install the CV shaft assembly in the hub, swing the whole assembly up and attach the lower control arm to the strut with the original hardware. Leave all hardware loose.

 **Tip** Assistance may be needed to install the knuckle assembly.

FIGURE 37A



FIGURE 37B



57. Attach the knuckle to the upper control arm with the original upper ball joint nut (Fig. 38).

FIGURE 38



- 58. Torque the upper ball joint nut to 37 ft-lbs and the lower ball joint nut to 74 ft-lbs.
- 59. Torque the CV axle nut to 155 ft-lbs.



Tip *This may need to be done on the ground with the weight of the vehicle.*

- 60. Torque the upper strut nuts and lower strut bolts to 40 ft-lbs.
- 61. Remove the factory tie rod ends and install the new provided tie rod ends. Leave approximately 1" of threads showing on the steering link.
- 62. Attach the ABS wire to the knuckle with the provided wire clamps and 6mm bolts, washers, and thread locker as shown in Figures 39A & B. Figure 39B shows the driver side with the brake sensor wire routing along the knuckle as well.



Tip *The hardware for the knuckles is located in bolt pack 847.*

FIGURE 39A

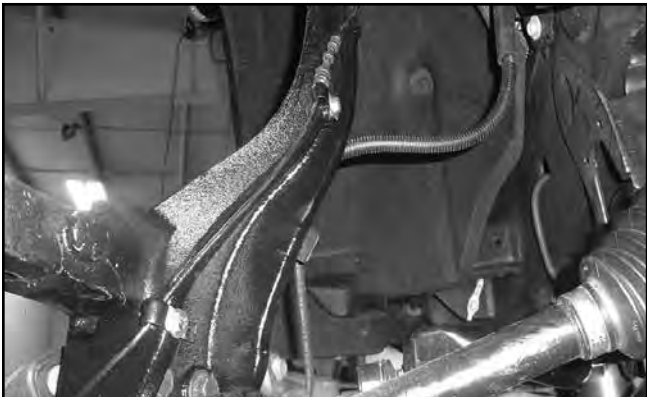

FIGURE 39B



- 63. Attach the brake sensor plug to the knuckle with the factory bracket and 6mm bolts, washers, and thread locker (Fig. 40).

FIGURE 40 - DRIVER SIDE ONLY



64. Attach the caliper to the new steering knuckle with the original mounting hardware and thread locker. Torque bolts to 125 ft-lbs.
65. Attach the brake line bracket to the knuckle with the provided 6mm bolt, washer, and thread locker (Fig. 41A).

Note: The tab on the driver side may need to be cut off to mount to the steering knuckle. (Fig. 41B)

FIGURE 41A



FIGURE 41B



66. Attach the ABS wire and brake sensor wire to the upper control arm on the driver and passenger sides with the relocation bracket (03673 & 03674) and factory hardware using thread locker. The passenger side will use the lower hole of the relocation bracket (Fig. 42).

Note: If the rubber grommet cannot reach the relocation bracket the plastic clip on the ABS line can be slid forward and inserted into the relocation bracket. (Fig. 42B)

FIGURE 42A -DRIVER SIDE SHOWN



FIGURE 42A -PASSENGER SIDE SHOWN

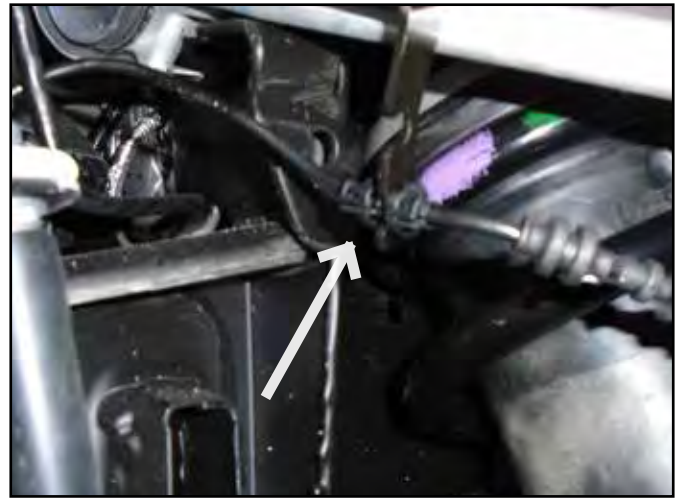

67. Attach the front sway bar to the sway bar drop bracket with the provided 3/8" bolts, prevailing torque nuts, and washers (Fig. 43). Attach the sway bar link to the front control arms.



Tip The hardware for the sway bar drop is located in bolt pack 422.

FIGURE 43



68. Connect the steering tie rod ends to the knuckles with the provided nylock nuts. Torque to 44 ft-lbs. Tighten the tie rod end jam nuts securely. They will be adjusted during alignment. Install the zerk fittings into the tie rod ends.
69. Install the wheels/tires and lower the front of the vehicle to the ground. Torque lug nuts to 140 ft-lbs.
70. Bounce the front of the vehicle to settle the suspension. Center the cams and torque the lower control arm mounting bolts to 200 ft-lbs. If the upper control arm bolts were loosened during the installation, torque the bolts to 125 ft-lbs.
71. Check differential and CV shafts for clearance in all areas including those cut for clearance.
72. Check all hardware for proper torque.
73. If necessary, bleed the entire brake system. See service manual for proper brake system bleeding procedures.
74. Reconnect the battery cables to the battery.

REAR INSTALLATION

1. Block the front wheels. Safely raise the rear of the vehicle and support with jack stands just ahead of the front leaf spring frame mount.
2. Remove the wheels.
3. Support the rear axle with a floor jack.
4. Disconnect the rear brake line bracket from the frame (Fig. 1). Save hardware.

FIGURE 1



5. Remove bolts attaching the ABS lines to the top of the rear differential (Fig. 2).

FIGURE 2

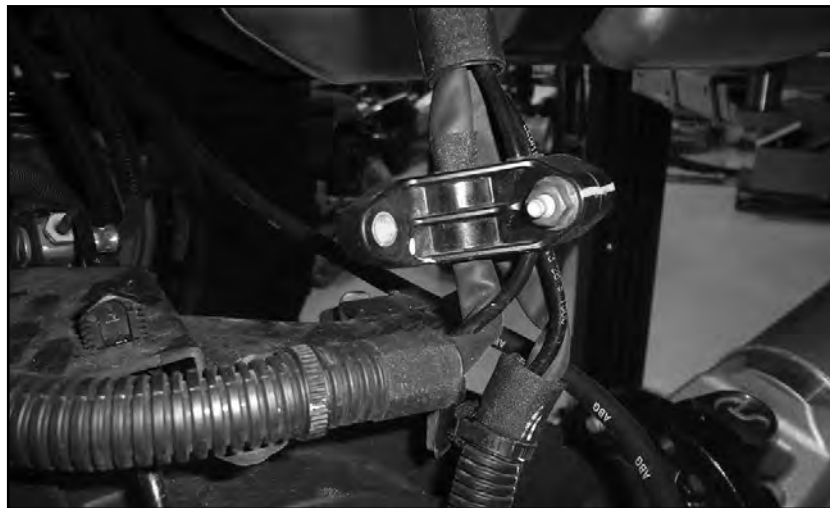

6. Support the center of the axle with a hydraulic jack. Remove the factory shocks from the axle and frame. Save hardware and discard shocks.
7. With the axle still well support remove the passenger's side u-bolts. The u-bolts will not be reused. Slowly lower the axle and remove the factory block from the axle. The factory block will not be reused.



Tip *If installing the optional add-a-leaf kit 111209, do so now following the instructions included in the kit. This portion of the installation should also be completed one side at time.*

The hole in the factory axle mount may need to be clearanced slightly for proper pin fitment.

8. Fasten a C-clamp on each side of the leaf spring center pin. With the clamps in place, remove the center pin and discard.

- Slide the new center pin up through the lower flat overload leaf and top two factory leaves. Remove the factory upper u-bolt plate and install the new u-bolt plate. Install the plate such that the long distance from the hole to the bend is towards the front of the vehicle (Fig. 3).



Tip Make sure the taper shim is installed in the same direction as it was from the factory.

FIGURE 3

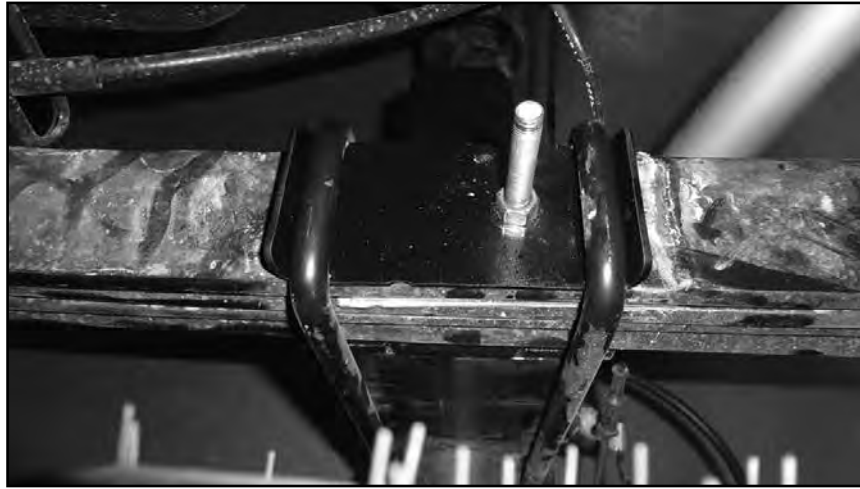

- Start the nut on the center pin to hold the pack together but do not use the center pin to pull the leaves together. When the pack is completely together, torque the center pin to 30 ft-lbs. Remove the C-clamps.
- Lower the axle just enough to install the new provided lift block between the axle and the spring. Position the block so the male pin side is forward when compared to the female or top of the block. This will assist in shifting the axle forward. Align the pin in the block with the hole in the axle and the hole in the block with the leaf spring pin. It may be necessary to loosen the driver's side u-bolts slightly to allow the axle to lower far enough to install the block.
- Using the support jack, raise the axle so that the axle, spring and block are all touching. Install the new provided u-bolts, nuts and washers along with the factory u-bolt plate. (Fig. 4) Snug u-bolts but do not tighten.

FIGURE 4



- Repeat the installation on the driver's side of the vehicle. Pay special attention to all of the brake lines and wires. Do not allow them to get over-extended.
- Remove the rear rubber bump stops from the frame. Access the bolt head up through the center of bump stop using a 10mm socket. Remove the bump stop and install the provided 3" diameter x 3" tall spacer between the bump stop and the frame mount with a 10mm x 110mm Allen head bolt and thread locker. Center the spacer on the lip of the factory bump stop cup and torque bolt to 35 ft-lbs. (Fig. 5)



Tip Hardware for the bump stop spacer is located in bolt pack 848.

FIGURE 5



15. Locate the new rear shocks. Install the provided bushings and steel sleeves into the eyes of the shocks. Lubricating the bushings and sleeves with some grease will make installation easier.
16. Install the new shocks with stock hardware and torque upper and lower bolts to 65 ft-lbs. The axle mounting tabs may need to be bent open slightly to allow for clearance of the larger diameter shocks.
17. Install the provided brake line bracket on the frame using the factory mounting hole and factory bolts. The bracket will offset away from the frame and towards the front of the vehicle. Attach the factory brake line bracket to the relocation bracket with two 5/16" x 1" bolt, prevailing torque nut, and washers. Torque the factory and 5/16" bolts to 15 ft-lbs. (Fig. 6)



Tip Hardware for the brake line bracket is located in hardware pack 848. Install the bracket with the notch up.

FIGURE 6



18. Install the provided ABS line bracket to the top of the rear differential using the factory mounting hole and factory bolts. The bracket will rotate the ABS line 90 degrees facing up. Attach the ABS line bracket to the relocation bracket with two 1/4" x 1" bolt, prevailing torque nut, and washers. Torque the factory and 1/4" bolt to 8 ft-lbs. (Fig. 7)



Tip Hardware for the ABS line bracket is located in hardware pack 848.

FIGURE 7



19. Install wheels and tires. Torque lug nuts to 140 ft-lbs. Lower vehicle.
20. Bounce the rear of the vehicle to settle the suspension. Torque leaf spring u-bolts to 100-120 ft-lbs. If new springs were installed, torque the spring-to-shackle and shackle-to-frame bolts to 70 ft-lbs. Torque the front spring hanger bolts to 125 ft-lbs.

POST INSTALLATION

21. Double check all fasteners for proper torque.
22. Check all moving parts for clearance.
23. Complete a full radius turning check to ensure that no interference occurs.
24. Align headlights
25. Double check the brake lines for adequate slack at full wheel travel.
26. Complete a vehicle alignment.
27. Check all fasteners after 500 miles.



WE WANT TO SEE YOUR RIDE!

Grab photos of your BDS-equipped truck in action and send them in for a chance to be featured. Send it in to our Bad Ass Rides customer gallery at bds-suspension.com/bar and post them on the BDS Fan Page on Facebook at facebook.com/BDSSuspensions. Don't forget about your BDS swag! BDS offers t-shirts, hoodies, decals and more available on the BDS website or through your local BDS distributor.

TIME TO HAVE SOME FUN

Thank you for choosing BDS Suspension.

For questions, technical support and warranty issues relating to this BDS Suspension product, please contact your distributor/installer before contacting BDS Suspension directly.